

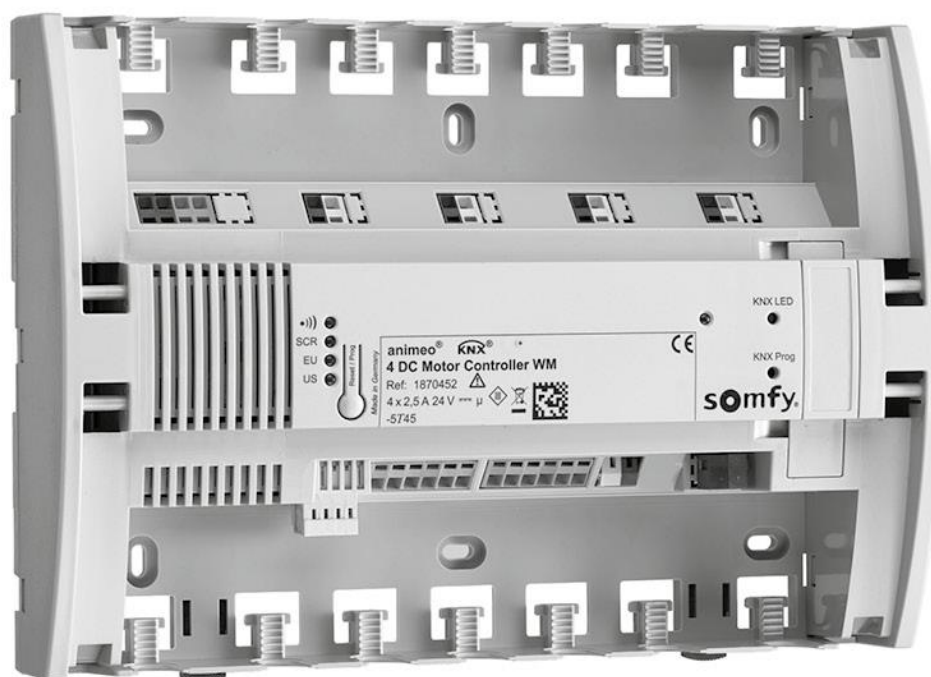

animeo

KNX 4 DC Motor Controller WM

Manual



Ref. 1870452

Table of contents

1	Definitions	4
1.1	Manual Command.....	4
1.2	Automatic Command.....	4
1.3	US push button ergonomics.....	4
1.4	EU push button ergonomics.....	4
1.5	Screen push button ergonomics	4
1.6	On/Off/Toggle.....	4
1.7	Position of the slats	5
2	Installation	6
3	Wiring diagramm	7
4	Settings in the delivery state	7
4.1	Function of the Reset/Prog button	8
4.2	Selection of different user ergonomics.....	9
4.3	Changing the ergonomics	9
4.4	Manual learning-in of move times	10
4.5	Manual learning-in of the intermediate position 1	10
4.6	Resetting to the delivery state.....	11
5	Communication objects	12
5.1	Object overview.....	12
6	Parameter	22
6.1	Menu index card “General”.....	22
6.2	Menu index card “Configuration for motor 1...4”	25
6.3	Menu index card “Functions for motor 1...4”	28
6.4	General information for Binary inputs.....	30
6.5	Menu index card “Binary inputs - Venetian blind Up/Down”	31
6.6	Menu index card “Binary inputs – Switch/Dry contact”	32
6.7	Menu index card “Binary inputs – 8-Bit value (rising edge)”	34
6.8	Menu index card “Binary inputs – Dimming”	35
6.9	Menu index card “General Binary inputs”	38
6.10	Menu index card “Electronic motors”	39
6.11	Menu index card “Bus safety”	40
6.12	Menu index card “Feedback motor position”	42
6.13	Menu index card “General Radio inputs”	44
6.14	General information for radio input.....	44
6.15	Menu index card “Radio inputs – Venetian blinds Up/Down”.....	45
6.16	Menu index card “Radio inputs – Switch”.....	46
6.17	Menu index card “Radio inputs – 8-Bit value”	49
6.18	Menu index card “Radio inputs – Dimming”	51
6.19	Menu index card “Radio inputs – Venetian blind slow tilting”.....	53
7	Technical data	55



Before starting up it is necessary to follow the safety instructions in these instructions. SOMFY cannot be held liable for defects and damages when these have been caused as a result of not following instructions (wrong installation, incorrect service etc.). Establishing, testing and starting up of the equipment is permitted only by a qualified person (in accordance with VDE 0100). Switch on all connections without voltage. Take precautions against unintentional turning on.

The installation of the Somfy products may occur only at easily accessible places. If maintenance and repair become substantially hindered by accessibility (e.g. stuck or extensively stuck flooring, installation behind lamps or behind façades), any originating supplementary costs therein cannot be charged to the seller.

Subject to technical changes.

The animeo KNX 4 DC Motor Controller WM 24 V DC is suited for selecting up to four individually parameterable motors for Venetian blinds, roller shutters, awnings and windows. The local push button inputs can be used as conventional push buttons or as universal KNX binary inputs.

Functions and advantages

- Time savings through easy installation, for example using spring connectors, strain relief cable binders, sufficient enough clamping space.
- A group input can be used to control all four motors independently of ETS programming.
- Testing the moving direction of the motors is possible without ETS.
- The device can be used in delivery state without programming with the ETS software.
- Four local push button inputs can be used as maximum to connect eight universal KNX binary inputs, for example window contacts, temperature switches or presence detectors. By using conventional push buttons, lighting can also be controlled and dimmed.
- User-friendly and intuitive parameter settings in the ETS software.
- Intelligent change-over between manual operation and automatic operation to guarantee excellent user friendliness and energy savings.
- Position messaging of the motors during the movement and when reaching the upper or lower end position.
- Two different safety positions, freely determinable for every individual motor output.
- Safety position with mains voltage return freely determinable and messaging over building.
- Automatic cascading of the outputs with mains voltage return and bus-safety functions to minimise power peaks.
- Plug and Play! Any time extendable with animeo RTS Radio Module (ref. 1860105) or animeo EnOcean Receiver (ref. 1860220). Without additional wiring the four motors can be controlled individually per radio using Somfy RTS technology.
- Alternatively the animeo KNX RTS Receiver (ref. 1860191) or animeo KNX EnOcean Receiver (ref. 1860229) can be used. Here, without additional wiring, up to 5 universal KNX radio binary inputs can be gained (e.g. light ON/OFF with DIM).



A complete commissioning is possible if the KNX Motor Controller is connected to and powered by the KNX bus.

1 Definitions

1.1 Manual Command

A manual command is a command which is generated by local conventional push buttons or by a Somfy RTS radio hand transmitter. A telegram which is sent on the objects 1-12 (bit commands) is also understood as a manual command.

1.2 Automatic Command

A telegram which is sent on the objects 13-20 (byte commands) is understood as an automatic command.

1.3 US push button ergonomics

With this parameter it is ensured that the Venetian blind is controlled in the US ergonomics over the local push button inputs or over the Somfy RTS radio hand transmitter.

Short pressing of the push button (< 0.5 s): A move command is carried out.

Long pressing of the push button (> 0.5 s): A turn command is carried out, as long as the push button is pressed. When released, the turn command is stopped.

If the current position of the Venetian blind is beyond the turn, a move command is carried out with pressed push button.

1.4 EU push button ergonomics

With this parameter it is ensured that the Venetian blind is controlled in the EU ergonomics over the local push button inputs or over the Somfy RTS radio hand transmitter.

Short pressing of the push button (< 0.5 s): A turn step is carried out.

Long pressing of the push button (> 0.5 s): A turn command is carried out as long as the push button is pressed.

If the current position of the Venetian blind is beyond the turn, a move command is carried out.

1.5 Screen push button ergonomics

With this parameter it is ensured that the end product is controlled in screen ergonomics over the local push button inputs or over the Somfy RTS radio hand transmitter.

Short pressing of the push button when the end product is moving: A stop command is carried out.

Long pressing of the push button when the end product is not moving: A drive command is carried out.

1.6 On/Off/Toggle

1.6.1 On

If an "On" telegram is generated the value "1" is transmitted on the corresponding KNX group address.

1.6.2 Off

If an "Off" telegram is generated the value "0" is transmitted on the corresponding KNX group address.

1.6.3 Toggle

If a "Toggle" telegram is generated the value is firstly inverted and then transmitted to the corresponding KNX group address.

1.7 Position of the slats

1.7.1 90°/0° Venetian blind

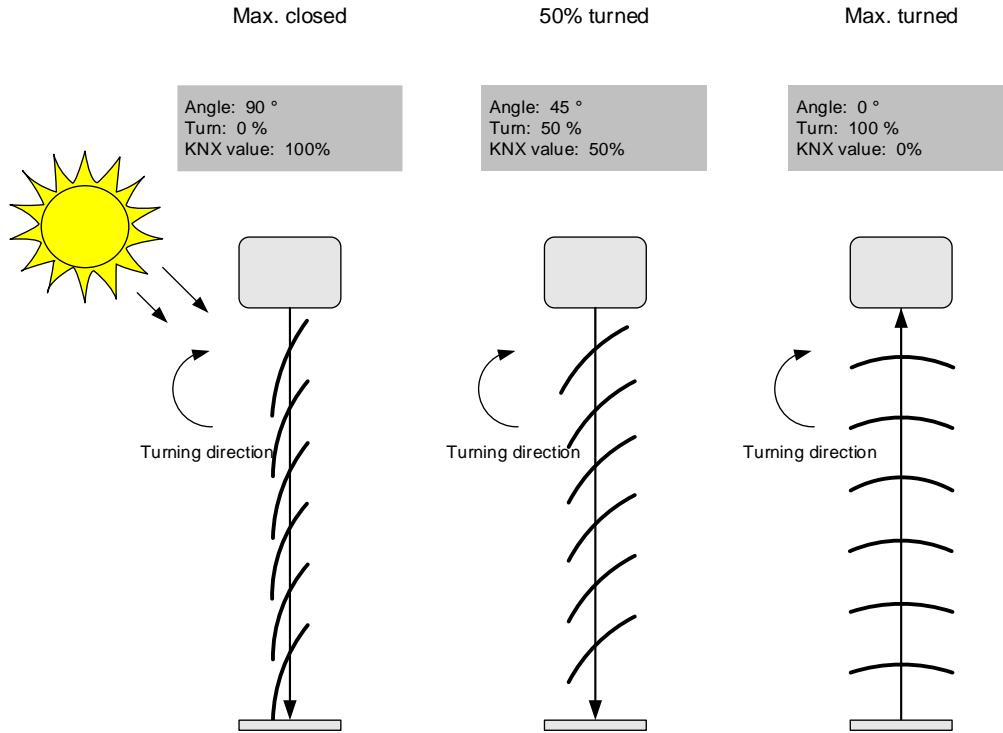

1.7.2 90°/-90° Venetian blind

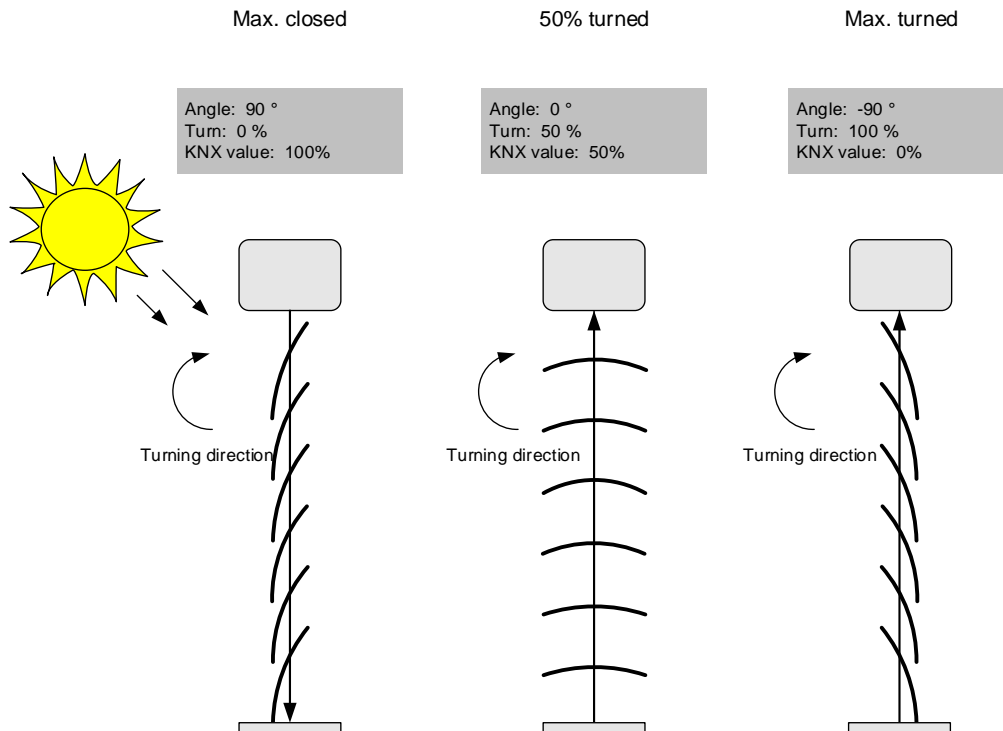

2 Installation

Choose the right place for installation: Level surface with sufficient space

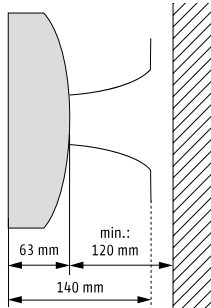

Installation of the Motor Controller 4 DC WM

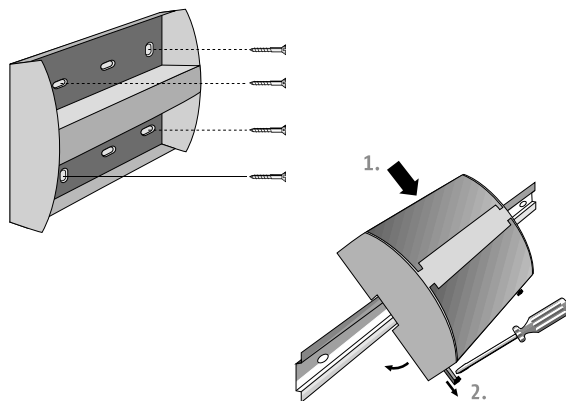

Complete wiring and connect power supply

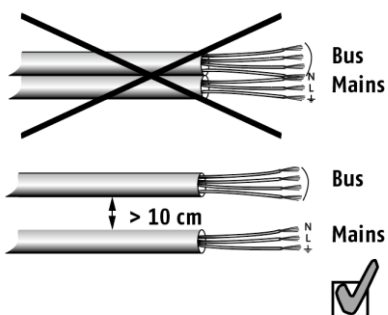

3 Wiring diagramm

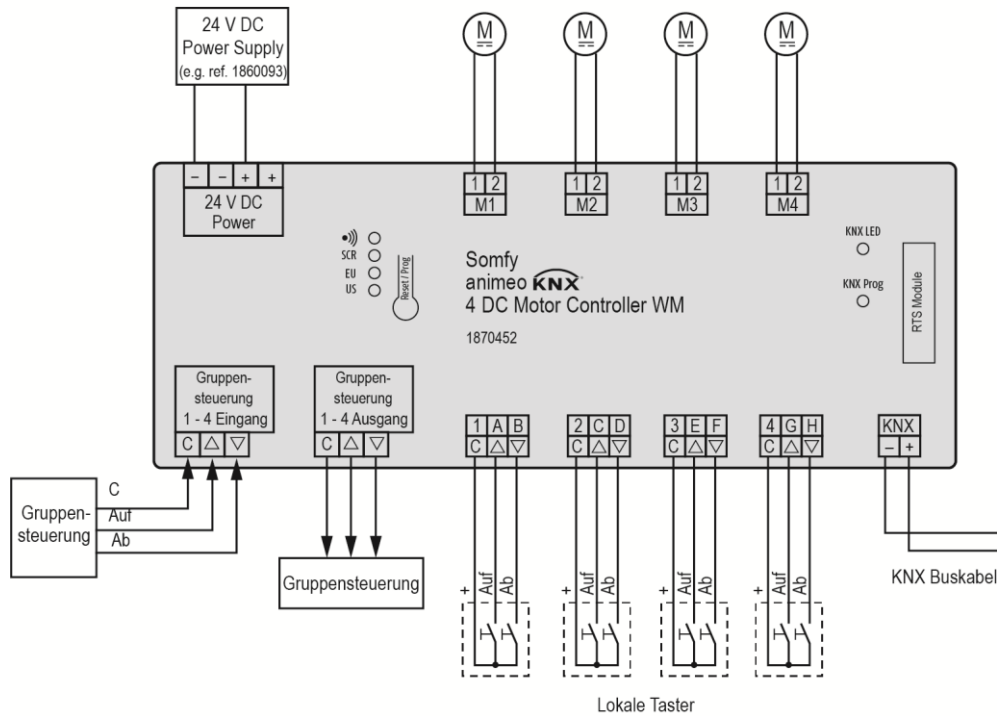

The “US”-LED blinks regularly when the mains (24 V) and the KNX bus voltage are connected actively on the device. The device is ready for operation when the “US” LED blinks.

Connection to ...	Cable	Twisted pair	Max. length	Stripping length
Motors	Min.: 2 x 0.6 mm/22 AWG Max.: 2 x 2.5 mm ² /13 AWG	-		6 mm/0.24"
Switch	Min.: 3 x 0.6 mm/22 AWG Max.: 3 x 2.5 mm ² /13 AWG	Recommended	100 m/330 ft	6 mm/0.24"
Group control	Min.: 3 x 0.6 mm/22 AWG Max.: 3 x 1.5 mm ² /15 AWG	Recommended	100 m/330 ft	6 mm/0.24"
KNX-Bus	2 x 0.8 mm/20 AWG	Required, according to KNX guidelines		6 mm/0.24"
24 V DC	Min.: 2 x 1.5 mm ² /15 AWG Max.: 2 x 2.5 mm ² /13 AWG	-	10 m/33 ft	6 mm/0.24"

4 Settings in the delivery state

The Motor Controller KNX can be used in the delivery state also without prior programming by the ETS software. Practical presets are implemented in the device. These settings apply to all four motor outputs.

- Move times UP/DOWN, CLOSED/OPEN = 5 minutes
- Connection of local conventional push buttons is possible

The local push button inputs are assigned directly to the motor outputs: Push button input 1 controls motor output 1 (fig. 1). The motor outputs can be controlled through bridging the wire at the push button inputs when required (fig. 2).

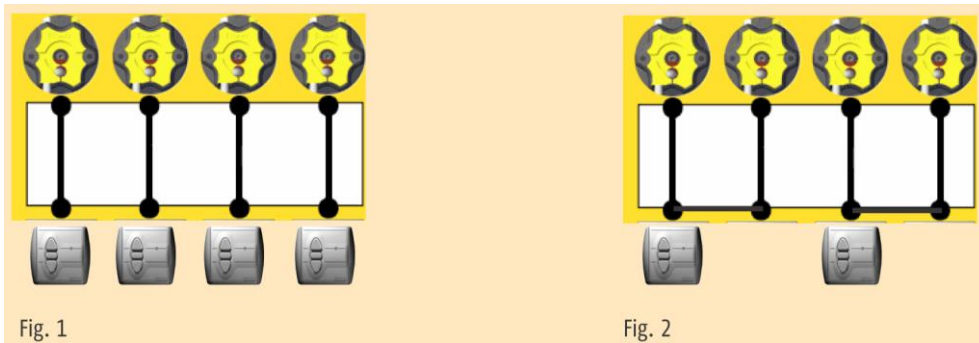

4.1 Function of the Reset/Prog button

⚠ The basic settings in the KNX Motor Controller can be made using this push button. These basic settings are possible only in the delivery state, before the device with the ETS was programmed, or after the device was unassigned by the ETS.

The basic settings are overwritten by the settings in the ETS.

4.2 Selection of different user ergonomics

Using the Reset/Prog button the press button user ergonomics for the local push button inputs or Somfy RTS radio hand transmitter can be determined. These settings are possible only in the delivery state, before the device is programmed with ETS software or after the device is unassigned with the ETS.

As soon as the device with the ETS is programmed, no further settings of the user ergonomics can be made via the Reset/Prog button. When the device is unassigned by the ETS, the adjusting of the user ergonomics is possible again via the Reset/Prog button.

⚠ The selection of the user ergonomics must match with a corresponding end product.



- = Learning-in of animeo RTS radio module
- SCR = Screen ergonomics*
- EU = Venetian blind, EU ergonomics*
- US = Venetian blind, US ergonomics*

*see chapter 1 "Definitions"

4.3 Changing the ergonomics

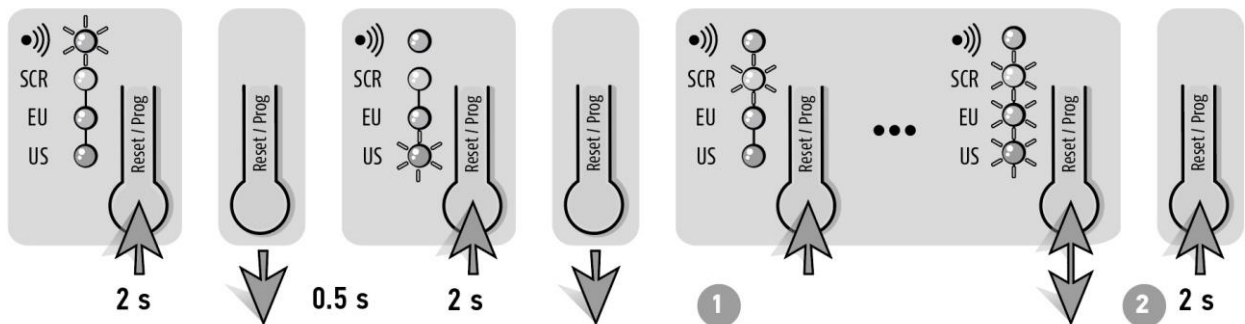

The delivery state is Venetian Blind with EU ergonomics

To change to different ergonomics press briefly the Reset/Prog button. Repeat till such time as the desired LED shines.

Save and exit the setting mode

4.4 Manual learning-in of move times

The move and turn times per motor output can be set via local conventional push buttons. These settings are possible only in the delivery state before the device has been programmed with the ETS. As soon as the device with the ETS is programmed, the move times and turn times can no longer be set via local conventional push buttons. When the device is unassigned by the ETS, the adjusting of the move times and turn times via local conventional push buttons can be done again.

⚠ Alternatively to the conventional push buttons, the settings can also be done using the Somfy RTS Transmitter and animeo RTS Radio Module (ref. 1860105). A setting using animeo KNX RTS Receiver (ref. 1860191) and Somfy RTS Transmitter resp. animeo EnOcean Receiver (ref. 1860220) or animeo KNX EnOcean Receiver (ref. 1860229) und EnOcean Receiver is not possible!

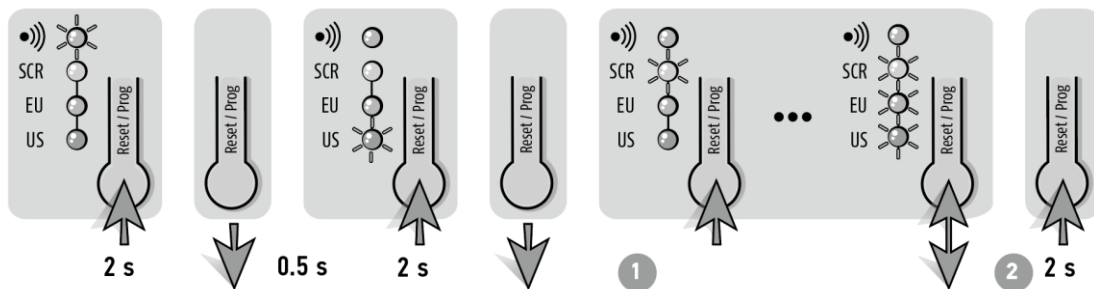

4.5 Manual learning-in of the intermediate position 1

Intermediate position 1 can be learned-in individually per motor output via conventional local push buttons. At the same time, it is possible to carry out the intermediate position 1 via settings in the ETS parameters. Prior to this, the move and turn times must be learned-in!

⚠ Alternatively to the conventional push buttons, the settings can also be done using the Somfy RTS Transmitter and animeo RTS Radio Module (ref. 1860105). A setting using animeo KNX RTS Receiver (ref. 1860191) and Somfy RTS Transmitter resp. animeo EnOcean Receiver (ref. 1860220) or animeo KNX EnOcean Receiver (ref. 1860229) and EnOcean Sender is possible through using the objects 64-67!

4.5.1 Save intermediate position 1 (IP1)

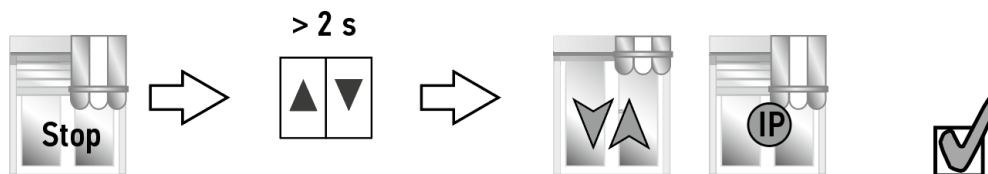

4.5.2 Call intermediate position 1 (IP1)

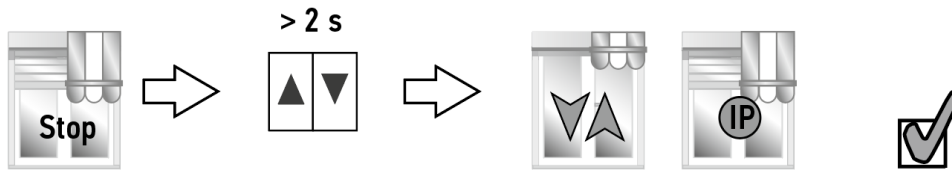

4.6 Resetting to the delivery state

When the device has not been programmed with the ETS software.

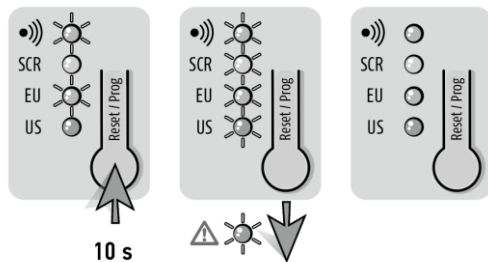

The setting made via the Reset/Prog push button can be set back to the delivery state by pressing the Reset/Prog button for 10 seconds.

When the device has been programmed with the ETS software.

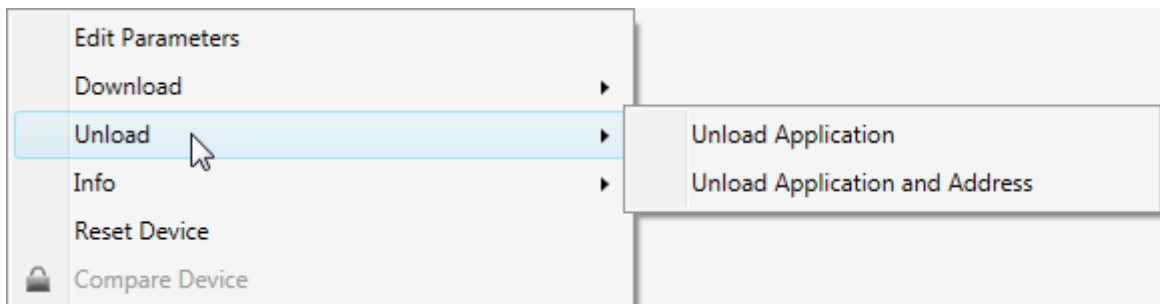

When the device has been programmed with the ETS software, a reset in the delivery state is no longer possible via the Rest/Prog button. Over the function “Unload” in the ETS, all settings of the device can be set back in the delivery state. The Reset/Prog button is then freed again.

5 Communication objects

5.1 Object overview

At the most, 177 communication objects are available for use, but not all at once. A maximum of 250 group addresses can be connected.

5.1.1 List of Objects

No.	Object name	Type	DPT_ID	Description
1	Motor 1 Up/Down, Close/Open	1 bit	1.008	If a telegram with the value "0" is received on this communication object, the appropriate blind goes up or the window closes. If a telegram with the value "1" is received, the appropriate blind goes down or the window opens. At expiration of the adjusted running time for the UP and DOWN direction the relays of the outputs are deactivated.
2	Motor 2 Up/Down, Close/Open	1 bit	1.008	
3	Motor 3 Up/Down, Close/Open	1 bit	1.008	
4	Motor 4 Up/Down, Close/Open	1 bit	1.008	
9	Motor 1 Step/Stop	1 bit	1.008	With Venetian blinds: If the Venetian blind is moving, the move is stopped with the receiving of a telegram on one of these communication objects, no matter whether "0" or "1" is received. If the Venetian blind is stationary, a turn is carried out. In addition, the slats turn CLOSED with the receiving of a telegram with the value "1" and UP with the receiving of a telegram with the value "0". The duration of the turning step is defined in the parameter settings. With vertical awnings, roller shutters, awnings and windows: When one of the end products is moving, the move is stopped with the receiving of a telegram on one of these communication objects, no matter whether "0" or "1" is received. If one of these end products is not moving and a telegram is received on one of these communication objects, then no operation is carried out.
10	Motor 2 Step/Stop	1 bit	1.008	
11	Motor 3 Step/Stop	1 bit	1.008	
12	Motor 4 Step/Stop	1 bit	1.008	
13	Motor 1 Position Up/Down	1 Byte	5.001	If a telegram is received on one of these communication objects, the corresponding blind will move to the position which is defined by the received value "0" = upper/"100" = lower. With Venetian blinds: When the position is reached, the same slats angle is moved to at which the Venetian blind was before.
14	Motor 2 Position Up/Down	1 Byte	5.001	
15	Motor 3 Position Up/Down	1 Byte	5.001	
16	Motor 4 Position Up/Down	1 Byte	5.001	
17	Motor 1 Slat position	1 Byte	5.001	With Venetian blinds: If a telegram is received on one of these communication objects, the corresponding slats will move to the position which is defined by the received value. If a Venetian blind
18	Motor 2 Slat position	1 Byte	5.001	
19	Motor 3 Slat position	1 Byte	5.001	

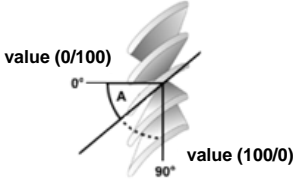
No.	Object name	Type	DPT_ID	Description
20	Motor 4 Slat position	1 Byte	5.001	<p>is moving and receives a value on the corresponding object, the position of the slats is moved to only when the move has been completed. Depending on the parameter settings on the card index "General" the position is defined as follows:</p> <p>"100" = slats max. closed/ "0" = slats max. turned or "0" = slats max. closed/ "100" = slats max. turned</p> 
25	Motor 1 Move to IP1	1 bit	1.008	<p>If a telegram with the value "1" is received on one of these communication objects, the corresponding blind moves to the ETS parameterized per local switch or to the radio transmitted, learned-in intermediate position 1, if the learned-in position is valid. With the receiving of a telegram with the value "0" on one of these communication objects, the corresponding blind moves to the upper end position.</p>
26	Motor 2 Move to IP1	1 bit	1.008	
27	Motor 3 Move to IP1	1 bit	1.008	
28	Motor 4 Move to IP1	1 bit	1.008	
29	Motor 1-4 Move to IP1	1 bit	1.008	<p>If a telegram with the value "1" is received on this communication object, the blinds 1-4 move to the ETS parameterized per local switch or to the radio transmitted, learned-in intermediate position 1, if the learned-in position is valid. With the receiving of a telegram with the value "0" on this communication object, the blinds 1-4 move to the upper end position.</p>
30	Motor 1 Move to IP2	1 bit	1.008	<p>If a telegram with the value "1" is received on one of these communication objects, the corresponding blind moves to the intermediate position 2 parameterized in the ETS parameters. With the receiving of a telegram with the value "0" on one of these communication objects, the corresponding blind moves to the upper end position.</p>
31	Motor 2 Move to IP2	1 bit	1.008	
32	Motor 3 Move to IP2	1 bit	1.008	
33	Motor 4 Move to IP2	1 bit	1.008	
34	Motor 1-4 Move to IP2	1 bit	1.008	<p>If a telegram with the value "1" is received on this communication object, the blinds move to the Intermediate Position (IP) 2 parameterized in the ETS parameters. With the receiving of a telegram with the value "0" on this communication object the blinds 1-4 move to the upper end position.</p>
40	Motor 1 Security, low prio	1 bit	1.001	<p>If a telegram with the value "1" is received on one of these communication objects, the corresponding blind moves to the position parameterized in the ETS parameters (Security, low prio) and any</p>
41	Motor 2 Security, low prio	1 bit	1.001	
42	Motor 3 Security, low prio	1 bit	1.001	

No.	Object name	Type	DPT_ID	Description
43	Motor 4 Security, low prio	1 bit	1.001	further move commands will be blocked. With the receiving of a telegram with the value "0" on one of these communication objects, the security is turned off and move commands will be accepted again. If "Repeat last telegram after security (Yes)" has been selected in the ETS parameters, the blind moves to the position it was, before security was activated. If on one of the communication objects 45-48 (Security, high prio) a telegram is received with the value "1", the corresponding blind moves to the position parameterized in the ETS (Security, high prio).
44	Motor 1-4 Security, low prio	1 bit	1.001	If a telegram with the value "1" is received on this communication object, the blinds 1-4 move to the position parameterized in the ETS parameters (Security, low prio) and any further move commands will be blocked. With the receiving of a telegram with the value "0" on this communication objects, the security is turned off and move commands will be accepted again. If "Repeat last telegram after security (Yes)" has been selected in the ETS parameters, the blinds move to the position they have been before security was activated. If on the communication object 49 (Security, high prio) a telegram is received with the value "1", the blinds 1-4 move to the position parameterized in the ETS (Security, high prio).
45	Motor 1 Security, high prio	1 bit	1.001	If a telegram with the value "1" is received on one of these communication objects, the corresponding blind moves to the position parameterized in the ETS parameters (Security, high prio) and any further move commands will be blocked. With the receiving of a telegram with the value "0" on one of these communication objects, the security is turned off and move commands will be accepted again, if the corresponding object 40-43 (Security, low prio) has the value "0". Otherwise the parameterized action for low security will be carried out. When "Repeat last telegram after security (Yes)" has been selected in the ETS parameters and both securities for the corresponding channel have the value "0", the blind moves to the position it was, before any security was activated.
46	Motor 2 Security, high prio	1 bit	1.001	
47	Motor 3 Security, high prio	1 bit	1.001	
48	Motor 4 Security, high prio	1 bit	1.001	

No.	Object name	Type	DPT_ID	Description
49	Motor 1-4 Security, high prio	1 bit	1.001	If a telegram with the value "1" is received on this communication object, the blinds 1-4 move to the position parameterized in the ETS parameters (Security, high prio) and any further move commands will be blocked. With the receiving of a telegram with the value "0" on this communication object, the security is turned off and move commands will be accepted again, if the object 44 (Security, low prio) has the value "0". Otherwise the parameterized action for low security will be carried out. If "Repeat last telegram after security (Yes)" has been selected in the ETS parameters and both securities have the value "0", the blinds move to the position they were, before any security was activated.
50	Motor 1-4 Status positions	1 bit	1.001	If a telegram with the value "1" or "0" is received on this communication object, the current status positions of the corresponding blinds are sent to the bus (objects 73-80).
51	Motor 1 Block functions	1 bit	1.001	If a telegram with the value "1" is received on one of these communication objects, the functions parameterized in the ETS for the corresponding blind is blocked. If a telegram with the value "0" is received on one of these communication objects, the functions parameterized in the ETS for the corresponding blind is no longer blocked and freed again.
52	Motor 2 Block functions	1 bit	1.001	
53	Motor 3 Block functions	1 bit	1.001	
54	Motor 4 Block functions	1 bit	1.001	
55	Motor 1-4 Block functions	1 bit	1.001	If a telegram with the value "1" is received on this communication object, the functions parameterized in the ETS for the blinds 1-4 are blocked. If a telegram with the value "0" is received on this communication object, the functions parameterized in the ETS for the blinds 1-4 are no longer blocked and freed again.
56	Motor 1 Prio automatic/manual	1 bit	1.003	Over these communication objects the priority automatic function and priority manual function can be switched. If a telegram with the value "1" is received on one of these communication objects, the automatic functions for the corresponding blind is prioritized activated. If a telegram with the value "0" is received on one of these communication objects, the manual functions for the corresponding blind is active.
57	Motor 2 Prio automatic/manual	1 bit	1.003	
58	Motor 3 Prio automatic/manual	1 bit	1.003	
59	Motor 4 Prio automatic/manual	1 bit	1.003	
60	Motor 1 Reset priority	1 bit	1.001	If a telegram with the value "1" or "0" is received on one of these communication objects the priority switching for the corresponding blind is reset. Automatic functions or manual functions are then switched to priority active again. Whichever priority is active depends on the status of the communication objects 62-65 or whichever priority has been parameterized in the ETS.
61	Motor 2 Reset priority	1 bit	1.001	
62	Motor 3 Reset priority	1 bit	1.001	
63	Motor 4 Reset priority	1 bit	1.001	
64	Motor 1 IP1 Save/Delete	1 bit	1.002	If a telegram with the value "1" is received on one of these communication objects the actual position for the corresponding blind is learned as IP1. If a telegram with the value "0" is received on one of these communication objects the IP1 is deleted.
65	Motor 2 IP1 Save/Delete	1 bit	1.002	
66	Motor 3 IP1 Save/Delete	1 bit	1.002	

No.	Object name	Type	DPT_ID	Description
67	Motor 4 IP1 Save/Delete	1 bit	1.002	
68	Main power failure (24 V)	1 bit	1.002	A mains power failure is signaled with this communication object. 20 seconds after the mains voltage cut out a telegram with the value "1" is sent to the bus. With return of mains voltage this communication object sends the telegram with the value "0".
73	Motor 1 Feedback UP/DOWN	1 Byte	5.001	Through these communication objects, the actual position, based on the learned-in move time (UP/DOWN direction) of the corresponding blind, is sent to the bus. This kind of sending (on demand, status change, cyclic) is set in the ETS parameters. "0" = upper/"100" = lower.
74	Motor 2 Feedback UP/DOWN	1 Byte	5.001	
75	Motor 3 Feedback UP/DOWN	1 Byte	5.001	
76	Motor 4 Feedback UP/DOWN	1 Byte	5.001	
77	Motor 1 Feedback slat	1 Byte	5.001	Through this communication objects, the actual slats position, based on the learned-in turn time, is sent to the bus. This kind of sending (on demand, status change, cyclic) is set in the ETS parameters. The position, dependent of parameter settings on the menu list "General", is defined as follows: "100" = slats max. closed/"0" = slats max. turned (standard) or "0" = slats max. closed/"100" = slats max. turned
78	Motor 2 Feedback slat	1 Byte	5.001	
79	Motor 3 Feedback slat	1 Byte	5.001	
80	Motor 4 Feedback slat	1 Byte	5.001	
81	Motor 1 Upper end position	1 bit	1.002	Through these communication objects a telegram with the value "1" for the corresponding blind is sent when the upper end position is reached. When leaving the upper end position of the corresponding blind, a telegram with the value "0" is sent. The upper and lower end position is determined by the parameterized move times.
82	Motor 2 Upper end position	1 bit	1.002	
83	Motor 3 Upper end position	1 bit	1.002	
84	Motor 4 Upper end position	1 bit	1.002	
85	Motor 1-4 Upper end position	1 bit	1.002	Through this communication object a telegram with the value "1" for the blinds 1-4 is sent when all four blinds have reached the upper end position. When all 4 blinds leave the upper end position, a telegram with the value "0" is sent. The upper and lower end position is determined by the parameterized move times.
91	Motor 1 Lower end position	1 bit	1.002	Through this communication objects a telegram with the value "1" for the corresponding blind is sent when all four blinds have reached the lower end position. When leaving the lower end position of the corresponding motor, a telegram with the value "0" is sent. The upper and lower end position is determined by the parameterized move times.
92	Motor 2 Lower end position	1 bit	1.002	
93	Motor 3 Lower end position	1 bit	1.002	
94	Motor 4 Lower end position	1 bit	1.002	
95	Motor 1-4 Lower end position	1 bit	1.002	Through this communication object a telegram with the value "1" is sent for the blinds 1-4 when all four blinds have reached the lower end position. When the corresponding blinds leave the lower end position, a telegram with the value "0" is sent. The upper and lower end position is determined by the parameterized move times.

No.	Object name	Type	DPT_ID	Description
96	Switch input 1: UP/DOWN	1 bit	1.008	A long pressing of the button on input A generates a telegram on this communication object with the value "0". The Venetian blind moves UP. A long pressing of the button on input B generates a telegram on this communication object with the value "1". The Venetian blind moves DOWN.
97	Switch input 1: STEP/STOP	1 bit	1.008	A short pressing of the button on input A generates a telegram on this communication object with the value "0". The slat turns UP. When the Venetian blinds are making a move then a short pressing of the button generates a stop command on input A. A short pressing of the switch on input B generates a telegram with the value "1". The slats turn CLOSE. When the Venetian blind is making a move then a short pressing of the button generates a stop command on input B.
98	Input 1: A, Switch	1 bit	1.001	According to the parameter settings and the state at input 1 contact A a switching telegram is sent over this communication object with the value "1" or "0".
99	Input 1: B, Switch	1 bit	1.001	According to the parameter settings and the state at input 1 contact B, a switching telegram is sent over this communication object with the value "1" or "0".
100	Switch input 1: A, 8-Bit value	1 Byte	5.010	According to the parameter settings, with a rising edge on input 1 contact A, the parameterized value (0-255) is sent.
101	Switch input 1: B, 8-Bit value	1 Byte	5.010	According to the parameter settings, with a rising edge on input 1 contact B, the parameterized value (0-255) is sent.
102	Switch input 1: A/B, Dimming	1 Bit	1.001	On/Off: According to the parameter settings, with a short pressing at the input 1 contact A/B, a telegram is generated with the value "1" or "0". Toggle/Toggle: According to the parameter settings, with a short pressing at the input 1 contact A/B, a telegram is generated with the value "1" or "0".
103	Switch input 1: A/B, Dimming, Value	4 Bit	3.007	Brighter/darker dimming: According to the parameter settings, brighter dimming is done with a long pressing at the input 1 contact A. According to the parameter settings, darker dimming is done with a long pressing at the input 1 contact B. Brighter/Darker toggle: According to the parameter settings, over input 1 contact A, 100 % is dimmed with longer pressing of the switch. When releasing the corresponding switch at the input A, a stop command is generated. The last activated dimming step becomes inverted. According to the parameter settings, over input 1 contact A, 100 % is dimmed with longer pressing of the switch. When releasing the corresponding switch at the input B, a stop command is generated. The last activated dimming step becomes inverted.

No.	Object name	Type	DPT_ID	Description
104	Switch Input 2: UP/DOWN	1 Bit	1.008	see description of object 96, C/D instead of A/B
105	Switch Input 2: STEP/STOP	1 Bit	1.008	see description of object 97, C/D instead of A/B
106	Switch Input 2: C, Switch	1 Bit	1.001	see description of object 98, C instead of A
107	Switch Input 2: D, Switch	1 Bit	1.001	see description of object 99, D instead of B
108	Switch Input 2: C, 8-Bit value	1 Bit	5.010	see description of object 100, C instead of A
109	Switch Input 2: D, 8-Bit value	1 Bit	5.010	see description of object 101, D instead of B
110	Switch Input 2: C/D, Dimming	1 Bit	1.001	see description of object 102, C/D instead of A/B
111	Switch Input 2: C/D, Dimming, value	4 Bit	3.007	see description of object 103, C/D instead of A/B
112	Switch Input 3: UP/DOWN	1 Bit	1.008	see description of object 96, E/F instead of A/B
113	Switch Input 3: STEP/STOP	1 Bit	1.008	see description of object 97, E/F instead of A/B
114	Switch Input 3: E, Switch	1 Bit	1.001	see description of object 98, E instead of A
115	Switch Input 3: F, Switch	1 Bit	1.001	see description of object 99, F instead of B
116	Switch Input 3: E, 8-Bit value	1 Bit	5.010	see description of object 100, E instead of A
117	Switch Input 3: F, 8-Bit value	1 Bit	5.010	see description of object 101, F instead of B
118	Switch Input 3: E/F, Dimming	1 Bit	1.001	see description of object 102, E/F instead of A/B
119	Switch Input 3: E/F, Dimming, value	4 Bit	3.007	see description of object 103, E/F instead of A/B
120	Switch Input 4: UP/DOWN	1 Bit	1.008	see description of object 96, G/H instead of A/B
121	Switch Input 4: STEP/STOP	1 Bit	1.008	see description of object 97, G/H instead of A/B
122	Switch Input 4: G, Switch	1 Bit	1.001	see description of object 98, G instead of A
123	Switch Input 4: H, Switch	1 Bit	1.001	see description of object 99, H instead of B
124	Switch Input 4: G, 8-Bit value	1 Bit	5.010	see description of object 100, G instead of A
125	Switch Input 4: H, 8-Bit value	1 Bit	5.010	see description of object 101, H instead of B
126	Switch Input 4: G/H, Dimming	1 Bit	1.001	see description of object 102, G/H instead of A/B
127	Switch Input 4: G/H, Dimming, value	4 Bit	3.007	see description of object 103, G/H instead of A/B
128	Radio Input 1: UP/DOWN	1 Bit	1.008	A long pressing of "UP" button at channel 1 learned in remote generates a telegram with the value "0" on this communication object. The Venetian blind goes UP. A long pressing of "DOWN" button at channel 1 learned in remote generates a telegram with the value "1" on this communication object. The Venetian blind goes DOWN.
129	Radio Input 1: STEP/STOP	1 Bit	1.008	A short pressing of "UP" button at channel 1 learned in remote generates a telegram with the value "0" on this communication object. The slat will tilt to reverse (open). If the Venetian blind is in the fully moving process with a short pressing of "UP" button at channel 1 learned in remote, a stop order is generated. A short pressing of "DOWN" button at channel 1 learned in remote generates a telegram with the value "1" on this communication object. The slat will tilt to close. If the Venetian blind is in a fully moving process with a short pressing of "DOWN" button at channel 1 learned in remote a stop order is generated.

No.	Object name	Type	DPT_ID	Description
130	Radio Input 1: Switch "my" button	1 Bit	1.001	According to the parameter settings a pressing of "my" button at channel 1 learned in remote generates a telegram with the value "1" or "0" on this communication object.
131	Radio Input 1: 8-Bit value "my" button	1 Byte	5.010	According to the parameter settings a pressing of "my" button at channel 1 learned in remote the configured value (0-255) is sent.
132	Radio Input 1: Switch "UP" button	1 Bit	1.001	According to the parameter settings a pressing of "UP" button at channel 1 learned in remote generates a telegram with the value "1" or "0" on this communication object.
133	Radio Input 1: Switch "DOWN" button	1 Bit	1.001	According to the parameter settings a pressing of "DOWN" button at channel 1 learned in remote generates a telegram with the value "1" or "0" on this communication object.
134	Radio Input 1: 8-Bit value "UP" button	1 Byte	5.010	According to the parameter settings a pressing of "UP" button at channel 1 learned in remote the configured value (0-255) is sent.
135	Radio Input 1: 8-Bit value "DOWN" button	1 Byte	5.010	According to the parameter settings a pressing of "DOWN" button at channel 1 learned in remote the configured value (0-255) is sent.
136	Radio Input 1: Dimming ON/OFF or Slow Tilting UP/DOWN	1 Bit	1.001	<p>On/Up: According to the parameter settings a short pressing of "UP" button at channel 1 learned in remote a telegram with the value "0" will be generated. The light will be switched ON or the blinds will move UP</p> <p>Off/Down: According to the parameter settings a short pressing of "DOWN" button at channel 1 learned in remote a telegram with the value "1" will be generated. The light will be switched OFF or the blinds will move DOWN</p> <p>Toggle/Toggle: According to the parameter settings a short pressing of "UP" or "DOWN" button at channel 1 learned in remote a telegram with the value "1" and/or "0" is generated. The light will be switched ON respectively OFF or the blinds will move UP respectively DOWN.</p>
137	Radio Input 1: Dimming Brighter/Darker or Slow Tilting Open/Close	4 Bit	3.007 3.008	<p>Brighter/darker dimming: According to the parameter settings of the input 1 contact A with a long actuation it is dimmed brighter. According to the parameter settings of the input 1 contact B with a long actuation it is dimmed darker.</p> <p>Brighter/darker toggle: According to the parameter settings of the input 1 contact A with a long actuation it is dimmed 100 %. When releasing the appropriate switch at the input A a stop order is generated. The dimming action operated last is thus inverted.</p> <p>According to the parameter settings of the input 1 contact B with a long actuation it is dimmed 100 %. When releasing the appropriate switch at the input B a stop order is generated. The dimming action operated last is thus inverted.</p>

No.	Object name	Type	DPT_ID	Description
138	Radio Input 2: UP/DOWN	1 Bit	1.008	see description of object 128, channel 2 instead of channel 1
139	Radio Input 2: STEP/STOP	1 Bit	1.008	see description of object 129, channel 2 instead of channel 1
140	Radio Input 2: Switch "my" button	1 Bit	1.001	see description of object 130, channel 2 instead of channel 1
141	Radio Input 2: 8-Bit value "my" button	1 Byte	5.010	see description of object 131, channel 2 instead of channel 1
142	Radio Input 2: Switch "UP" button	1 Bit	1.001	see description of object 132, channel 2 instead of channel 1
143	Radio Input 2: Switch "DOWN" button	1 Bit	1.001	see description of object 133, channel 2 instead of channel 1
144	Radio Input 2: 8-Bit value "UP" button	1 Byte	5.010	see description of object 134, channel 2 instead of channel 1
145	Radio Input 2: 8-Bit value "DOWN" button	1 Byte	5.010	see description of object 135, channel 2 instead of channel 1
146	Radio Input 2: Dimming	1 Bit	1.001	see description of object 136, channel 2 instead of channel 1
147	Radio Input 2: Dimming/slow tilting	4 Bit	3.007 3.008	see description of object 137, channel 2 instead of channel 1
148	Radio Input 3: UP/DOWN	1 Bit	1.008	see description of object 128, channel 3 instead of channel 1
149	Radio Input 3: STEP/STOP	1 Bit	1.008	see description of object 129, channel 3 instead of channel 1
150	Radio Input 3: Switch "my" button	1 Bit	1.001	see description of object 130, channel 3 instead of channel 1
151	Radio Input 3: 8-Bit value "my" button	1 Byte	5.010	see description of object 131, channel 3 instead of channel 1
152	Radio Input 3: Switch "UP" button	1 Bit	1.001	see description of object 132, channel 3 instead of channel 1
153	Radio Input 3: Switch "DOWN" button	1 Bit	1.001	see description of object 133, channel 3 instead of channel 1
154	Radio Input 3: 8-Bit value "UP" button	1 Byte	5.010	see description of object 134, channel 3 instead of channel 1
155	Radio Input 3: 8-Bit value "DOWN" button	1 Byte	5.010	see description of object 135, channel 3 instead of channel 1
156	Radio Input 3: Dimming	1 Bit	1.001	see description of object 136, channel 3 instead of channel 1
157	Radio Input 3: Dimming/slow tilting	4 Bit	3.007 3.008	see description of object 137, channel 3 instead of channel 1
158	Radio Input 4: UP/DOWN	1 Bit	1.008	see description of object 128, channel 4 instead of channel 1
159	Radio Input 4: STEP/STOP	1 Bit	1.008	see description of object 129, channel 4 instead of channel 1
160	Radio Input 4: Switch "my" button	1 Bit	1.001	see description of object 130, channel 4 instead of channel 1
161	Radio Input 4: 8-Bit value "my" button	1 Byte	5.010	see description of object 131, channel 4 instead of channel 1
162	Radio Input 4: Switch "UP" button	1 Bit	1.001	see description of object 132, channel 4 instead of channel 1
163	Radio Input 4: Switch "DOWN" button	1 Bit	1.001	see description of object 133, channel 4 instead of channel 1
164	Radio Input 4: 8-Bit value "UP" button	1 Byte	5.010	see description of object 134, channel 4 instead of channel 1
165	Radio Input 4: 8-Bit value "DOWN" button	1 Byte	5.010	see description of object 135, channel 4 instead of channel 1

No.	Object name	Type	DPT_ID	Description
166	Radio Input 4: Dimming	1 Bit	1.001	see description of object 136, channel 4 instead of channel 1
167	Radio Input 4: Dimming/slow tilting	4 Bit	3.007 3.008	see description of object 137, channel 4 instead of channel 1
168	Radio Input 5: UP/DOWN	1 Bit	1.008	see description of object 128, channel 5 instead of channel 1
169	Radio Input 5: STEP/STOP	1 Bit	1.008	see description of object 129, channel 5 instead of channel 1
170	Radio Input 5: Switch "my" button	1 Bit	1.001	see description of object 130, channel 5 instead of channel 1
171	Radio Input 5: 8-Bit value "my" button	1 Byte	5.010	see description of object 131, channel 5 instead of channel 1
172	Radio Input 5: Switch "UP" button	1 Bit	1.001	see description of object 132, channel 5 instead of channel 1
173	Radio Input 5: Switch "DOWN" button	1 Bit	1.001	see description of object 133, channel 5 instead of channel 1
174	Radio Input 5: 8-Bit value "UP" button	1 Byte	5.010	see description of object 134, channel 5 instead of channel 1
175	Radio Input 5: 8-Bit value "DOWN" button	1 Byte	5.010	see description of object 135, channel 5 instead of channel 1
176	Radio Input 5: Dimming	1 Bit	1.001	see description of object 136, channel 5 instead of channel 1
177	Radio Input 5: Dimming/slow tilting	4 Bit	3.007 3.008	see description of object 137, channel 5 instead of channel 1

6 Parameter

The selection options of the single parameters are described in each case. The defaults are printed in italics. In the following illustrations of the different parameter cards the maximum number of parameters is shown. Besides this and depending on the parameter settings, objects which are not required are hidden.

6.1 Menu index card “General”

1.1.1 animeo KNX 4 DC Motor Controller WM > General		
General	Motor output configuration	<input type="radio"/> Combined <input checked="" type="radio"/> Individual
Motor 1	Select priority Automatic/Manual	<input checked="" type="radio"/> No <input type="radio"/> Yes
Motor 2	Use universal binary inputs	<input checked="" type="radio"/> No <input type="radio"/> Yes
Motor 3	Use radio binary inputs (only with 1860191/1860229)	<input type="radio"/> No <input checked="" type="radio"/> Yes
Motor 4	Group control input	<input checked="" type="radio"/> Enabled <input type="radio"/> Disabled
Functions motor 1	Slat position closed/reversed ONLY FOR VENETIAN BLINDS	<input checked="" type="radio"/> Max. closed (100)/Max. reversed (0) <input type="radio"/> Max. closed (0)/Max. reversed (100)
Functions motor 2		
Functions motor 3		
Functions motor 4		
Electronic motors		
Bus safety		
Feedback motor position		

6.1.1 Standard settings of the motors

- Default value:
 - Combined
- Selection options:
 - Combined
 - Individual

With these parameters the settings of the motor outputs are made as to whether “Combined” or “Individual”. With the parameter “Combined” only one menu index card becomes visible for the basic settings of all four motor outputs (motor 1-4).

⚠ The selection „Combined“ is recommended for projects for which the settings of the motor outputs are the same.

With the parameter „Individual“ four single cards become visible for the standard settings of the motor outputs (motor 1, motor 2, ...).

6.1.2 Select priority Automatic/Manual

- Default value:
 - No
- Selection options:
 - No
 - Yes

With the parameter “Yes” the settings for the priority functions become visible. At the same time the necessary objects appear.

6.1.3 Motor 1...4 Automatic/Manual functions

- Default value: • None
 Selection options: • None
 • Priority automatic function
 • Priority manual function

- **None**

The move commands are carried out in the incoming order sequence.

- **Priority automatic function**

If an automatic command (1 byte move command) occurs before a manual command (1-bit move command), all manual commands are disabled. The objects at the start-up of the intermediate positions 1 and 2 (objects 25-34) are also disabled. A manual command is also generated over the local push button inputs or via the radio transmitter. However, a turn command (1 bit) can always be made within the parameterized turning time. A reset of the priority automatic function occurs when "Priority reset" (60-63) receives "1" or "0" on the corresponding object. Shifting between priority manual functions (value "0") and priority automatic functions (value "1") is done over the corresponding objects (56-59). After changing over to the corresponding priority the function is again in the reset state. This means that for priority automatic functions the manual commands are blocked only with the next automatic command.

△ See chapter 1 Definitions.

- **Priority manual function**

When a manual command (1 bit) occurs before an automatic command (1 byte), all automatic commands are disabled. A manual command is also generated over the local push button inputs or via the radio transmitter. A reset of the priority manual function occurs when "Priority reset" (60-63) receives "1" or "0" on the corresponding object. Shifting between priority manual functions (value "0") and priority automatic functions (value "1") is done over the corresponding objects (56-59). After changing over to the corresponding priority the function is again in the reset state. This means that for priority automatic functions the manual commands are disabled only with the next automatic command

△ See chapter 1 Definitions.

△ Over the priority manual function the user has the option of switching off the automatic functions. User comfort can be defined, for example, with a timer. At 8:00 o'clock the priority manual function is activated over the corresponding object (56-59) and the user can move to the desired position using the manual functions until priority automatic functions are switched over at around 17:00 on priority automatic functions toggles. Over the corresponding object (56-59), switching to and from priority manual function and priority automatic function can be done at any time.

△ See chapter 1 Definitions.



To set the timer, ideally the façade controller animeo KNX Master Control W2 (Ref. 1860187) or animeo KNX Master Control W8 (Ref. 1860193) can be used.

6.1.4 Use universal binary inputs

- Default value: • No
Selection options: • No
 • Yes

With the parameter “Yes”, five further menu index cards open (General: Binary inputs and Binary input 1...4). Now the local push button inputs can be connected over the corresponding objects (96-127). A conventional push button can then be used for many different functions. For example, Switching, Venetian blind function, Dimming or Sending a value.

6.1.5 Use radio binary inputs

- Default value: • No
Selection options: • No
 • Yes

With the parameter “Yes” a menu index card opens (General: Radio binary input), over which five further menu index cards can be activated (Radio binary input 1...5). Now the radio channels can be connected over the corresponding objects (128-177). A radio transmitter can then be used for many different functions.

6.1.6 Group control input

- Default value: • Disabled
Selection options: • Enabled
 • Disabled

Over this parameter it is determined whether the input is blocked to the group control or is freed. Over this input all four motors are selected at the same time. Regardless of the parameter settings, the security settings (objects 40-49) have higher priority. If one of the security objects is active, the input to the group control is blocked.

 With a bus power failure this input is freed. Even if it is blocked over the parameter settings it can be used as an emergency service. With bus voltage return this input is blocked according to parameter settings or is freed.

6.1.7 Slats turn closed/turned ONLY WITH VENETIAN BLIND

- Default value: • Max. closed (100 %)/Max. turned (0 %)
Selection options: • Max. closed (100 %)/Max. turned (0 %)
 • Max. closed (0 %)/Max. turned (100 %)

• **Max. closed (100 %)/Max. turned (0 %)**

If the value “100” is transmitted to the corresponding object (17–20), the slats are closed at maximum.

If the value “0” is transmitted to the corresponding object (17–20), the slats are turned or opened at maximum.

• **Max. closed (0 %)/Max. turned (100 %)**

If the value “0” is transmitted to the corresponding object (17–20), the slats are closed at maximum.

If the value “100” is transmitted to the corresponding object (17–20), the slats are turned or opened at maximum.

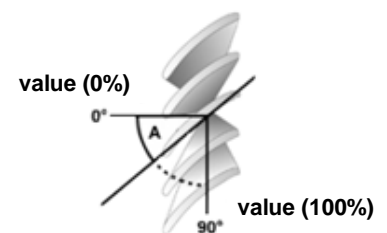

6.2 Menu index card “Configuration for motor 1...4”

1.1.1 animeo KNX 4 DC Motor Controller WM > Motor 1		
General	Type of end product	Venetian blind with EU ergonomics
Motor 1	Running time Up/Close Base 0,1s (1-3200)	1200
Motor 2	Running time Down/Open Base 0,1s (1-3200)	1200
Motor 3	Complete tilting time Base 0,1s (0-200)	12
Motor 4	Step length Base 0,05s (2-200)	4
Functions motor 1	Slack compensation Base 0,1s (0-50)	0
Functions motor 2	Security position Low priority	Ignore security
Functions motor 3	Security position High priority	Upper end limit
Functions motor 4	Cyclic monitoring time in min. (0-255)	0
Electronic motors		
Bus safety		
Feedback motor position		

Four single menu index cards (motor 1...4) become visible if in the menu of the basic setting “Motors” the parameter setting “Individual” is selected. One menu index card (motor 1 - 4) becomes visible if in the menu of the basic setting “Motors” the parameter setting “Combined” is selected.

6.2.1 Type of end product

- Default value: • Venetian blind with EU ergonomics
- Selection options: • Venetian blind with EU ergonomics
• Venetian blind with US ergonomics
• Screen, roller shutter, awning
• Window

• Venetian blind with EU ergonomics:

With this parameter it is determined that the Venetian blind in EU ergonomics is selected over the local push button inputs or via the Somfy RTS radio transmitter.

When the local push button inputs are used as universal push button inputs, the operating ergonomics are defined over the corresponding parameters (short/long pressing of the push button). The operating ergonomics using a Somfy RTS radio transmitter remains unchanged.

△ For an explanation of EU/US ergonomics and screen ergonomics see chapter 1 Definitions.

• Venetian blind with US ergonomics

With this parameter it is determined that the Venetian blind in US ergonomics is selected over the local push button inputs or via the Somfy RTS radio transmitter.

When the local push button inputs are used as universal push button inputs, the operating ergonomics are defined over the corresponding parameters (short/long pressing of the push button). The operating ergonomics using a Somfy RTS radio transmitter remains unchanged.

△ For an explanation of EU/US ergonomics and screen ergonomics see chapter 1 Definitions.

- **Screen, roller shutter, awning**

With this parameter it is determined that the corresponding blind is selected over move/stop commands when the controlling is done over the local push button inputs or via the Somfy RTS radio hand transmitter. When the local push button inputs are used as universal push button inputs, the operating ergonomics are defined over the corresponding parameters (short/long pressing of the push button). The operating ergonomics using a Somfy RTS radio transmitter remains unchanged.

△ For an explanation of EU/US ergonomics and screen ergonomics see chapter 1 Definitions.

- **Window**

With this parameter it is determined that the corresponding window is selected over move/stop commands when the controlling is done over the local push button inputs or via the Somfy RTS radio hand transmitter. When the local push button inputs are used as universal push button inputs, the operating ergonomics are defined over the corresponding parameters (short/long pressing of the push button). The operating ergonomics using a Somfy RTS radio transmitter remains unchanged.

△ For an explanation of EU/US ergonomics and screen ergonomics see chapter 1 Definitions.

6.2.2 Running time Up/Close

Default value: • 120 seconds
Selection options: • 0.1 - 320 seconds

The time parameterized here is the maximum running time from the lower end position to the upper end position, or the maximum running time which a window motor needs to close the corresponding window. An excess time of 5 seconds is always added, except with position telegrams (objects 13-16). If a position telegram with the value "0" is sent to the corresponding object, an excess time of 5 seconds is still added to it.

6.2.3 Running time Down/Open

Default value: • 120 seconds
Selection options: • 0.1 - 320 seconds

The time parameterized here is the maximum running time from the lower end position to the upper end position or the maximum running time which a window motor needs to open the corresponding window. An excess time of 5 seconds is always added to it, except with position telegrams (objects 13-16). If a position telegram with the value "100" is received on the corresponding object, an excess time of 5 seconds is still added to it.

6.2.4 Complete tilting of the slats

Default value: • 1.2 seconds
Selection options: • 0 - 20 seconds

The parameterized time here is the maximum tilting time of the slats. This parameter is only visible when the "Type of end product" is set to Venetian blind with EU ergonomics or Venetian blind with US ergonomics.

△ For an explanation of EU/US ergonomics see chapter 1 Definitions.

6.2.5 Step length

Default value: • 0.2 seconds
Selection options: • 0.1 - 10 seconds

The parameterized time here is the move time for a turn step. This parameter is only visible when the type of end product, Venetian blind with EU ergonomics or Venetian blind with US ergonomics is selected.

△ For an explanation of EU/US ergonomics see chapter 1 Definitions.

6.2.6 Slack compensation

- Default value: • 0 seconds
Selection options: • 0 - 5 seconds

The time slack compensation is active as soon as a higher value than “0” is entered. The time parameterized here defines the time which is added to the parameterized complete slats turn to balance out mechanical tolerances. This time is always added with the first UP turn of the slats when the type of end product, Venetian blinds with EU ergonomics or Venetian blinds with US ergonomics have been selected.

△ For an explanation of EU/US ergonomics see chapter 1 Definitions.

6.2.7 Security position Low priority

- Default value: • Ignore security
Selection options: • Upper end limit
 • Lower end limit
 • Intermediate position 1 (IP 1)
 • Intermediate position 2 (IP 2)
 • Ignore security
 • Stop
 • Close window
 • Open window

The “Security position low priority” for the corresponding blind is determined with this parameter. If a telegram with the value “1” is received on one of these communication objects (objects 40-43) the corresponding blind moves to the position parameterized in the ETS parameters.

If a telegram with the value “0” is received on one of these communication objects, no operation is carried out. If the function “Repeat last telegram after security” is set with “Yes” in the menu index card “Functions motor 1...4”, the blind moves, after ending of the “Low priority” (value “0”), again in the last position and angle before activation of this priority.

6.2.8 Security position High priority

- Default value: • Upper end limit
Selection options: • Upper end limit
 • Lower end limit
 • Ignore security
 • Stop
 • Close window
 • Open window

The “Security position high priority” for the corresponding blind is determined with this parameter. If a telegram with the value “1” is received on one of these communication objects (objects 45-48), the corresponding blind moves to the position parameterized in the ETS parameters.

If a telegram with the value “0” is received on one of these communication objects, no operation is carried out.

If the function “Repeat last telegram after security” is set with “Yes” in the menu index card “Functions motor 1...4”, it is checked whether “Low priority” is active or inactive. When “Low priority” (value “1”) is active the blinds move to the parameterized “Security position low priority” (see previous point). If the “Low priority” (value “0”) is also inactive, the blind moves again to the last position with the last angle before activating the high and low priorities.

6.2.8.1 Cyclic monitoring time in minutes (0–255)

- Default value: • 0
Selection options: • 0 - 255 minutes

The cyclic monitoring time is active and refers to the high and low priority security objects.

△ The cyclic transmitter must be approximately 4 times faster than the cyclic monitoring. E.g. if the cyclic sending of the transmitter is set to 1 minute, then the cyclic monitoring time should be set to ≥4 minutes.

6.3 Menu index card “Functions for motor 1...4”

1.1.1 animeo KNX 4 DC Motor Controller WM > Functions motor 1		
General	Intermediate Position 1 (IP1)	
Motor 1	Up/Down position (0-100%)	0
Motor 2	Slat position (0-100%)	0
Motor 3	Intermediate Position 2 (IP2)	
Motor 4	Up/Down position (0-100%)	0
	Slat position (0-100%)	0
Functions motor 1	Block position orders (1 Byte) and IP 2	<input checked="" type="radio"/> No <input type="radio"/> Yes
Functions motor 2	Block slat orders (1 Byte)	<input checked="" type="radio"/> No <input type="radio"/> Yes
Functions motor 3	Block Up/Down orders (1 Bit) and Intermediate Position 1 (IP1)	<input checked="" type="radio"/> No <input type="radio"/> Yes
Functions motor 4	Block Step/Stop orders (1 Bit)	<input checked="" type="radio"/> No <input type="radio"/> Yes
Electronic motors	Block local push button inputs and Somfy RTS orders	<input checked="" type="radio"/> No <input type="radio"/> Yes
Bus safety	Repeat last telegram after security	<input checked="" type="radio"/> No <input type="radio"/> Yes
Feedback motor position		

Four single menu index cards (Functions motor 1...4) become visible if on the menu card index “General”, the basic setting of the blinds on “Individual” is parameterized. A menu index card (Motor 1 - 4) becomes visible if on the menu card index “General”, the basic setting of the motors is parameterized to “Combined”.

6.3.1 Intermediate Position 1 (IP1)

6.3.1.1 Up/Down position (0-100%)

Default value: • 0 % (function disabled)
Selection options: • 0 - 100 %

With this parameter the intermediate position 1 “UP/DOWN” is defined. The set value in % refers to the parameterized move times of the corresponding blind of the menu index card Motor 1...4/Motor 1 - 4. If the IP UP/Down position parameter is set to 0 %, the IP position is disabled. This function avoids any movement of the blinds by using the “my” or IP push button.

6.3.1.2 Slat position (0-100%)

Default value: • 0 %
Selection options: • 0 - 100 %

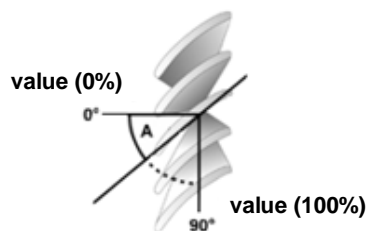

With this parameter the intermediate position 1 “slats” is defined. The set value in % refers to the parameterized complete slats turn of the corresponding blind of the menu index card Motor 1...4/Motor 1 - 4.

△ Intermediate position 1 can be learned-in individually via conventional local push buttons or by a radio handheld transmitter per motor output. In addition, the last learned-in position applies.

6.3.2 Intermediate Position 2 (IP2)

6.3.2.1 Up/Down position (0-100%)

- Default value: • 0 % (function disabled)
Selection options: • 0 - 100 %

With this parameter the intermediate position 2 “UP/DOWN” is defined. The set value in % refers to the parameterized move times of the corresponding blind of the menu index cards Motor 1...4/Motor 1-4. If the IP UP/Down position parameter is set to 0 %, the IP position is disabled. This function avoids any movement of the blinds by using the “my” or IP push button.

6.3.2.2 Slat position (0-100%)

- Default value: • 0 %
Selection options: • 0 - 100 %

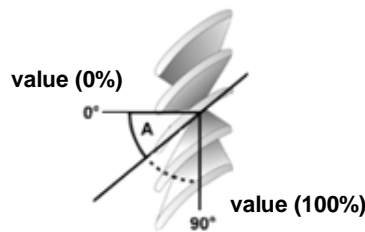

With this parameter the intermediate position 2 “Slats” is defined. The set value in % refers to the parameterized complete slats turn of the corresponding Venetian blind of the menu index card Motor 1...4/Motor 1-4.

6.3.3 Block position orders (1 Byte) and IP2

- Default value: • No
Selection options: • No
 • Yes

Position orders (byte) can be blocked per object (51-54) using this parameter. If a telegram with the value “1” is received on the corresponding object during a blinds move, this move is carried out up to the end. Only then are further move commands (byte) blocked. If a telegram with the value “0” is received on the corresponding object, the move commands (byte) are released again.

6.3.4 Block slat orders (1 Byte)

- Default value: • No
Selection options: • No
 • Yes

Slat orders (byte) can be blocked per object (51-54) using this parameter. If a telegram with the value “1” is received on the corresponding object when the Venetian blind is turning, this move is carried out up to the end. Only then are further slat orders (byte) blocked. If a telegram with the value “0” is received on the corresponding object, the slat orders (byte) are released again.

6.3.5 Block Up/Down (1 Bit) and Intermediate Position 1 (IP 1)

- Default value: • No
Selection options: • No
 • Yes

UP/DOWN orders (bit) can be blocked per object (51-54) using this parameter. If a telegram with the value “1” is received on the corresponding object during a blinds move, this move is carried out up to the end. Only then are further UP/DOWN orders (bit) blocked. If a telegram with the value “0” is received on the corresponding object, the UP/DOWN orders (bit) are released again.

6.3.6 Block Step/Stop orders (1 Bit)

- Default value: • No
Selection options: • No
 • Yes

Step/stop and turn commands (bit) can be blocked per object (51-54) using this parameter. If a telegram with the value "1" is received on the corresponding object during a blinds turn, this turn is carried out up to the end. Only then further turn commands (bit) are blocked. If a telegram with the value "0" is received on the corresponding object, the step/stop or turn commands (bit) are released again.

6.3.7 Block local push button inputs and Somfy RTS orders

- Default value: • No
Selection options: • No
 • Yes

Local push buttons inputs and the Somfy RTS radio signal can be blocked per object (51-54) using this parameter. If a telegram with the value "1" is received on the corresponding object during a motor movement, this turn is carried out up to the end. Only after completion any further commands are blocked which are generated via local push button inputs or Somfy RTS radio signals. If a telegram with the value "0" is received on the corresponding object, the local push button inputs and Somfy RTS radio signals are freed again.

△ This function is deactivated for local push-button inputs if "Yes" has been selected in the "Use universal binary inputs" menu index card (see section 6.1.4).

6.3.8 Repeat last telegram after security

- Default value: • No
Selection options: • No
 • Yes

If this parameter is set to "Yes", the last move command is repeated after security. This means that it will move to the position which was active before a telegram with the value "1" was input to one of the corresponding security objects, low or high.

6.4 General information for Binary inputs

Four different basis functions can be selected for each universal input:

- Default value: • Venetian blind, Up/Down
Selection options: • Venetian blind, Up/Down
 • Switch dry contact
 • 8-Bit value (rising edge)
 • Dimming

The single functions and parameters will be explained which arise depending on the selection of the basis function. For this, another basis function has been selected for each push button. The functions are described with the help of the input 1 contact A/B and are identical for the inputs 2-4, contacts C/D, E/F and G/H.

△ For the basis function "Venetian blind Up/Down" attention must be paid to which contact "Up" or "Down" is switched. The same applies with selection basis function "Dimming", for "Brighter" or "Darker" dimming. The pre-setting of the basis function for the menu index card push button 1...4 is Venetian blind Up/Down.

6.5 Menu index card “Binary inputs - Venetian blind Up/Down”

1.1.1 animeo KNX 4 DC Motor Controller WM > Binary input 1, A/B		
General	Basic Function	Venetian blind, Up/Down
Motor 1-4	Long operation (move) after	0,5 Seconds
Functions motor 1-4	Contact type input A	<input type="radio"/> Normally closed <input checked="" type="radio"/> Normally open
	Contact type input B	<input type="radio"/> Normally closed <input checked="" type="radio"/> Normally open
Binary input 1, A/B		
Binary input 2, C/D		
Binary input 3, E/F		
Binary input 4, G/H		
General: Binary inputs 1-4		

6.5.1 Basic Function

Selected option:

- Venetian blinds Up/Down

6.5.2 Long operation (move) after

Default value:

- 0.5 seconds

 Selection options:

- 0.3 - 5.0 seconds

This parameter defines the activity time of the corresponding push button which distinguishes between the sending of a short-term telegram (step/stop) and a long-term telegram (Up/Down). If the time, for example, is set on 0.5 seconds, a long-term telegram is generated first with a longer pressing of the push button which is longer than 0.5 seconds. With a shorter activation which is smaller than 0.5 seconds, a short-term telegram is generated.

6.5.3 Contact type input A

Default value:

- Normally open

 Selection options:

- Normally open
- Normally closed

Over this parameter it is defined which type of contact is at the local input A.

Normally open: The contact at the local input is activated closed and not activated opened.

Normally closed: The contact at the local input is activated opened and not activated closed.

6.5.4 Contact type input B

Default value:

- Normally open

 Selection options:

- Normally open
- Normally closed

Over this parameter it is defined which type of contact is at the local input B.

Normally open: The contact at the local input is activated closed and not activated opened.

Normally closed: The contact at the local input is activated opened and not activated closed.

6.6 Menu index card “Binary inputs – Switch/Dry contact”

1.1.1 animeo KNX 4 DC Motor Controller WM > Binary input 1, A/B		
General	Basic Function	Switch/dry contact
Motor 1-4	Edge evaluation contact A	Rising On, falling Off
Functions motor 1-4	Edge evaluation contact B	Rising On, falling Off
Binary input 1, A/B	Send starting value on Bus power return	<input checked="" type="radio"/> No <input type="radio"/> Yes
Binary input 2, C/D	Contact A and B Cyclic sending of status	No cyclic sending
Binary input 3, E/F		
Binary input 4, G/H		
General: Binary inputs 1-4		

6.6.1 Basic Function

Selected option:

- Switch dry contact

6.6.2 Edge evaluation contact A

Default value:

- Rising On, falling Off

 Selection options:

- Rising On, falling Off
- Rising Off, falling On
- Rising On
- Falling On
- Rising Off
- Falling Off
- Rising toggle
- Falling toggle
- Rising toggle, falling toggle
- No evaluation

△ See chapter 1 Definitions for On (“1”) Off (“0”) Toggle (“1/0”).

The corresponding object value “0” or “1” is generated depending on which edge evaluation is parameterized.

- **Rising On, falling Off**

If a rising edge at the local input appears, the object value “On” is generated. If a falling edge at the local input appears, the object value “Off” is generated. The duration of the activation is not evaluated.

- **Rising Off, falling On**

If a rising flank at the local input appears, the object value “Off” is generated. If a falling flank at the local input appears, the object value “On” is generated. The duration of the activation is not evaluated.

- **Rising On**

If a rising flank at the local input appears, the object value “On” is generated. If a falling flank at the local input appears, it is not evaluated. The duration of the activation is not evaluated.

- **Falling On**

If a rising flank at the local input appears, the object value “On” is generated. If a rising flank at the local input appears, it is not evaluated. The duration of the activation is not evaluated.

- **Rising Off**

If a rising flank at the local input appears, the object value “Off” is generated. If a falling flank at the local input appears, this is not evaluated. The duration of the activity is not evaluated.

- **Falling Off**

If a falling flank at the local input appears, the object value “Off” is generated. If a rising flank at the local input appears, this is not evaluated. The duration of the activity is not evaluated.

- **Rising toggle**

If a rising flank at the local input appears, the object value is inverted. If a falling flank at the local input appears, this is not evaluated. The duration of the activity is not evaluated.

- **Falling toggle**

If a falling flank at the local input appears, the object value is inverted. If a rising flank at the local input appears, this is not evaluated. The duration of the activity is not evaluated.

- **Rising toggle, falling toggle**

If a rising or falling flank at the local input appears, the object value is inverted. The duration of the activity is not evaluated.

- **No evaluation**

If a rising or falling flank at the local input appears, this is not evaluated.

6.6.3 Edge evaluation contact B

For detailed information see Edge evaluation contact A.

6.6.4 Send starting value on Bus power return

- Default value: • No
Selection options: • Yes
 • No

If this parameter is stopped, the current state of the input is transmitted with the bus voltage return. If this parameter is set to “No”, the current state of the input is not transmitted.

6.6.5 Contact A and B Cyclic sending of status

- Default value: • No cyclic sending
Selection options: • No cyclic sending
 • On
 • Off
 • On and Off

With this parameter it is defined whether the corresponding switch value of the communication object should be transmitted cyclically.

- **No cyclic sending**

The switching value of the communication object is not transmitted cyclically.

- **On**

If the object value is “1”, this is transmitted cyclically. If the object value changes by flank change at the local input or reception of a telegram on “0”, the cyclic sending stops.

- **Off**

If the object value is “0”, this is transmitted cyclically. If the object value changes by flank change at the local input or reception of a telegram on “0”, the cyclic sending stops after “1”.

- **On and Off**

If the object value is “1” or “0”, this is transmitted cyclically. If the object value changes by flank change at the local input or with reception of a telegram, the current object value is transmitted cyclically.

6.6.6 Cyclic sending

- Default value: • 5 seconds
Selection options: • 1 – 3600 seconds

With this parameter the time intervals are defined in which the corresponding object value should be transmitted cyclically.

⚠ Please beware that cyclical supervision time of the receiver is approximately 4 times higher than that of the transmitter.

6.7 Menu index card “Binary inputs – 8-Bit value (rising edge)”

1.1.1 animeo KNX 4 DC Motor Controller WM > Binary input 1, A/B		
General	Basic Function	8-Bit value (rising edge)
Motor 1-4	Contact type input A	<input type="radio"/> Normally closed <input checked="" type="radio"/> Normally open
Functions motor 1-4	Contact A Value on rising edge (0-255)	0
Binary input 1, A/B	Contact type input B	<input type="radio"/> Normally closed <input checked="" type="radio"/> Normally open
Binary input 2, C/D	Contact B Value on rising edge (0-255)	0
Binary input 3, E/F		
Binary input 4, G/H		
General: Binary inputs 1-4		

6.7.1 Basic Function

- Selected option: • 8-Bit value (rising edge)

6.7.2 Contact type input A

- Default value: • 0
Selection options: • 0 – 255

With this parameter the value is set which is transmitted with a rising edge to the local input A.

6.7.3 Contact A value on rising edge (0-255)

- Default value: • Normally open
Selection options: • Normally open
 • Normally closed

With this parameter it is defined which contact type is at the local input A.

Normally open: The contact at the local input is activated closed and not activated opened.

Normally closed: The contact at the local input is activated opened and not activated closed.

6.7.4 Contact type input B

- Default value: • 0
Selection options: • 0 – 255

With this parameter the value is set which is transmitted with a rising edge at the local input B.

6.7.5 Contact B value on rising edge (0-255)

- Default value: • Normally open
Selection options: • Normally open
• Normally closed

With this parameter it is defined which contact type is at the local input B.

Normally open: The contact at the local input is activated closed and not activated opened.

Normally closed: The contact at the local input is activated opened and not activated closed.

6.8 Menu index card “Binary inputs – Dimming”

1.1.1 animeo KNX 4 DC Motor Controller WM > Binary input 1, A/B		
General	Basic Function	Dimming
Motor 1-4	Long operation (dimming) after	0,5 Seconds
Functions motor 1-4	Input A/B	<input checked="" type="radio"/> On/Off <input type="radio"/> Toggle/toggle
Binary input 1, A/B	Contact type input A	<input type="radio"/> Normally closed <input checked="" type="radio"/> Normally open
Binary input 2, C/D	Contact type input B	<input type="radio"/> Normally closed <input checked="" type="radio"/> Normally open
Binary input 3, E/F	Dimming with	<input checked="" type="radio"/> Stop telegram <input type="radio"/> Cyclic intervals
Binary input 4, G/H		
General: Binary inputs 1-4		

6.8.1 Basic Function

- Selected option: • Dimming

6.8.2 Long operation (dimming) after

- Default value: • 0.5 seconds
Selection options: • 0.3 - 5.0 seconds

This parameter defines the activity time of the corresponding push button which makes a distinction between the sending of a switching telegram and a dimming telegram. If the time, for example, is parameterized on 0.5 seconds, a dimming telegram is generated only after a press longer than 0.5 seconds is made. With a pressing shorter than 0.5 seconds a switch telegram is generated.

6.8.3 Input A/B

- Default value: • On/Off
Selection options: • On/Off
• Toggle/Toggle

This parameter defines the value which is transmitted with a short pressing of the corresponding input.

- **On/Off**

With a short pressing of the push button at the input A, an “Off” telegram is generated. With a short activity of the corresponding push button at the input B, an “On” telegram is generated. This function can be inverted by changing over the clamps at the inputs.

- **Toggle/Toggle**

Switching over can be done with a short pressing of the push button at the input A or B. This means that the value which is in the corresponding switching object is firstly inverted and is then transmitted.

△ See chapter 1 Definitions for On (“1”) Off (“0”) Toggle (“1/0”).

6.8.4 Contact type input A

- Default value: • Normally open
Selection options: • Normally open
 • Normally closed

With this parameter it is defined which contact type is at the corresponding local input.
Normally open: The contact at the local input is activated closed and not activated open.
Normally closed: The contact at the local input is activated open and not activated closed.

6.8.5 Contact type input B

- Default value: • Normally open
Selection options: • Normally open
 • Normally closed

With this parameter it is defined which contact type is at the corresponding local input.
Normally open: The contact at the local input is activated closed and not activated open.
Normally closed: The contact at the local input is activated open and not activated closed.

6.8.6 Dimming with

- Default value: • Stop telegram
Selection options: • Cyclic intervals
 • Stop telegram

- **Cyclic intervals**

With a short pressing of the push button at the local input A or B, an “On” or an “Off” telegram is generated over the corresponding object (1 bit). With a long pressing of the push button at the local input A brighter dimming is done over the corresponding object (4 bit) as long as the push button is pressed. When the push button is released on the local input A cyclical sending is stopped. The length of steps and the time duration for brighter dimming is made from the parameters “longer push button pressing (dimming)” and “interval for cyclical dimming”.

With a long pressing of the push button at the local input B, darker dimming is done over the corresponding object (4 bit) as long as the push button is pressed. When the push button is released on the local input B, cyclical sending is stopped. The length of steps and the time duration for darker dimming is made from the parameters “longer push button pressing (dimming)” and “interval for cyclical dimming”.

- **Stop telegram**

With a short pressing of the push button at the local input A or B, a telegram is generated over the corresponding object (1 bit). With a long pressing of the push button at the local input A brighter dimming is done over the corresponding object (4 bit). With a long pressing of the push button at the local input B, darker dimming is done over the corresponding object (4 bit). When the corresponding push button at the local input A or B is released, a stop command is generated.

6.8.7 Dimming Brighter/Darker

- Default value: • Adjust by $\frac{1}{8}$
- Selection options: • Adjust by 100%
- Adjust by $\frac{1}{2}$
 - Adjust by $\frac{1}{4}$
 - Adjust by $\frac{1}{8}$
 - Adjust by $\frac{1}{16}$
 - Adjust by $\frac{1}{32}$
 - Adjust by $\frac{1}{64}$

This parameter defines the dimming length of steps of the telegrams which are transmitted with a longer pressing.

⚠ When “Dimming with cyclic intervals” is parameterized, attention must be paid to the fact that the dimming length of steps and the interval for the cyclical dimming are matched to the dimming time of the actuator.

6.8.8 Interval for cyclic dimming

- Default value: • 0.5 seconds
- Selection options: • 0.5 - 7.0 seconds

This parameter defines the duration of an interval for cyclical sending. If, for example, a “change $\frac{1}{4}$ ” and an “interval of 0.5 seconds” is set, then with a longer pressing of the push button on the corresponding local input, every 0.5 seconds $\frac{1}{4}$ brighter or darker will be dimmed.

6.9 Menu index card “General Binary inputs”

1.1.1 animeo KNX 4 DC Motor Controller WM > General: Binary inputs 1-4		
General	Additional start-up delay	0 Seconds
Motor 1-4	Limit number of telegrams	<input type="radio"/> No <input checked="" type="radio"/> Yes
Functions motor 1-4	Limit	127 telegrams per 17 sec.
Binary input 1, A/B		
Binary input 2, C/D		
Binary input 3, E/F		
Binary input 4, G/H		
General: Binary inputs 1-4		
Electronic motors		

The parameters set here refer to the push button inputs 1 - 4.

6.9.1 Additional start-up delay

- Default value: • 0 seconds
 Selection options: • 0 seconds
 • 0 - 21 seconds

This parameter defines the time which is needed after bus voltage return, until the first telegram can be transmitted.

6.9.2 Limit number of telegrams

- Default value: • No
 Selection options: • Yes
 • No

This parameter opens the parameter to set the telegram rate limitation. In addition, the number of the telegrams which are transmitted cyclically per time unit can be limited.

6.9.3 Limit

- Default value: • 127 telegrams per 17 sec.
 Selection options: • 30 telegrams per 17 sec.
 • 60 telegrams per 17 sec.
 • 100 telegrams per 17 sec.
 • 127 telegrams per 17 sec.

This parameter defines the number of the telegrams which can be transmitted within 17 seconds.

6.10 Menu index card “Electronic motors”

1.1.1 animeo KNX 4 DC Motor Controller WM > Electronic motors		
General	Start delay Motor 1 Base 0,01s (0-100)	6
Motor 1-4	Start delay Motor 2 Base 0,01s (0-100)	0
Functions motor 1-4	Start delay Motor 3 Base 0,01s (0-100)	0
Electronic motors	Start delay Motor 4 Base 0,01s (0-100)	0
Bus safety		
Feedback motor position		

On this menu index card a start-up delay can be set for every single motor output.

6.10.1 Start delay Motor 1...4

- Default value:
- 0 seconds
- Selection options:
- 0 seconds
 - 0 – 100 seconds

If electronic motors are controlled using this Motor Controller, it is imperative to set the start delay time of the electronic motor in the settings of the Motor Controller.

6.11 Menu index card “Bus safety”

1.1.1 animeo KNX 4 DC Motor Controller WM > Bus safety		
General	Motor 1	
Motor 1-4	Reaction at bus power failure	Ignore
Functions motor 1-4	Reaction at bus power return	Ignore
Electronic motors	Motor 2	
Bus safety	Reaction at bus power failure	Ignore
Feedback motor position	Reaction at bus power return	Ignore
	Motor 3	
	Reaction at bus power failure	Ignore
	Reaction at bus power return	Ignore
	Motor 4	
	Reaction at bus power failure	Ignore
	Reaction at bus power return	Ignore
	Reaction at power return (24V) (for all motors)	Ignore
	Automatic cascading reduces power spikes through motors	<input checked="" type="radio"/> No <input type="radio"/> Yes

On this menu index card, the reaction can be defined for every single motor output with bus power failure and bus power return.

6.11.1 Motor 1...4

6.11.1.1 Reaction at bus power failure

- Default value:
 - Ignore
- Selection options:
 - Upper end limit
 - Lower end limit
 - Ignore
 - Intermediate position 1 (IP 1)
 - Intermediate position 2 (IP 2)
 - Close window
 - Open window

This parameter defines the position which is moved to with a bus power failure.

6.11.1.2 Reaction at bus power failure

- Default value:
 - Ignore
- Selection options:
 - Upper end limit
 - Lower end limit
 - Ignore
 - Intermediate position 1 (IP 1)
 - Intermediate position 2 (IP 2)
 - Close window
 - Open window

This parameter defines the position which is moved to with a bus power failure.

6.11.2 Reaction at main power return (24 V) (for all motors)

- Default value: • Ignore
 Selection options: • Upper end limit
 • Lower end limit
 • Ignore
 • Close window
 • Open window

This parameter defines the position which is moved to with a mains power return (24 V).

6.11.3 Automatic cascading

- Default value: • No
 Selection options: • No
 • Yes

If this parameter is set on “Yes”, the motor outputs with one second delay in each case move to the corresponding position. This delay time is taken into account with the start-up of the positions, which are generated from the settings “Reaction with bus voltage return” and “Reaction with mains voltage return (24 V)”.

⚠ Advantage: Power spikes can thus be reduced in larger projects.

6.12 Menu index card “Feedback motor position”

1.1.1 animeo KNX 4 DC Motor Controller WM > Feedback motor position		
General	Feedback of status Upper/Lower end positions	<input type="radio"/> No <input checked="" type="radio"/> Yes
Motor 1-4	Type of feedback Upper/Lower end positions	<input checked="" type="radio"/> Combined, if all are Up/Down <input type="radio"/> Individual
Functions motor 1-4		
Electronic motors	Motor 1 Feedback	Up/Down position
Bus safety	Motor 2 Feedback	Slat position
	Motor 3 Feedback	Up/Down and Slat position
	Motor 4 Feedback	None
Feedback motor position	Motor 1-4 Type of feedback	Cyclic
	Every	5 s

On this menu index card the parameters can be selected to announce the position status of the individual blinds on the bus. In addition, the generated status positions are based on the parameterized move times and turn times of the menu index cards motor 1...4 or motor 1 - 4.

6.12.1 Feedback of status Upper/Lower end positions

- Default value:
 - No
 Selection options:
 - No
 - Yes

This parameter opens the parameter “Type of feedback Upper/Lower end positions”.

6.12.2 Type of feedback Upper/Lower end positions

- Default value:
 - Combined if all are Up/Down
 Selection options:
 - Combined if all are Up/Down
 - Individual

• Combined if all are Up/Down

If this parameter is selected, the corresponding upper or lower end position is only announced on the bus, when all four blinds have reached the upper (object 85) or the lower (object 95) end position.

• Individual

If this parameter is selected, the corresponding upper or lower end position is announced on the bus for each blind individually. Here, the objects in each case (81-84) and (91-94) are made available.

6.12.3 Motor 1...4 Feedback

- Default value:
 - None
 Selection options:
 - Up/Down position
 - Slat position
 - Up/Down and slat position
 - None

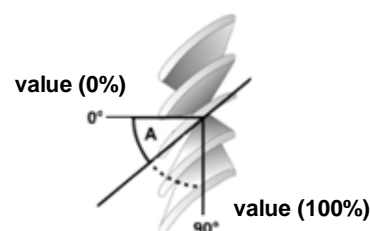

- **Up/Down position**

Using this parameter the position Up/Down is sent on the bus for the corresponding motor depending on the parameter "Type of messaging" "0" = upper/"255" = lower.

- **Slat position**

With this parameter the slat position is transmitted for the corresponding motor depending on the parameter "Type of messaging" on the bus. "0/255" = slats opened/"255/0" = slats closed. The value for the position of the slats which is transmitted over the corresponding object is dependent on the parameter settings on the menu index card "General".

Slats turn Closed/Turned ONLY WITH VENETIAN BLIND.

- **Up/Down and slat position**

With this parameter the position Up/Down and the position of the slats for the corresponding motor is transmitted on the bus depending on the parameter "Type of messaging". "0" = upper/"255" = lower, "0/255" = slats opened/"255/0" = slats closed. The value for the position of the slats which is transmitted over the corresponding object is dependent on the parameter settings on the menu index card "General".

Slats turn Closed/Turned ONLY WITH VENETIAN BLIND.

- **None**

No positions on the bus are messaged.

6.12.4 Motor 1...4 Type of feedback

Default value: • On demand
Selection options: • On demand
 • Status change
 • Cyclic

- **On demand**

The current position of the blinds must be requested over object 50.

- **Status change**

The current position of the corresponding blind is transmitted after every position change on the bus. The position is transmitted on the bus when the destination position is reached.

- **Cyclic**

This parameter opens a further parameter ("Every") with which the time for cyclical sending is set.

6.12.5 Every

Default value: • 5 seconds
Selection options: • 5 seconds
 • 10 seconds
 • 20 seconds
 • 30 seconds
 • 60 seconds

 With this parameter it is defined in which time intervals the current position of the corresponding blinds are messaged. The current position of the blinds is transmitted on the bus.

6.13 index card “General Radio inputs”

1.1.1 animeo KNX 4 DC Motor Controller WM > General: Radio binary inputs		
General	Radio binary input 1	<input checked="" type="radio"/> No <input type="radio"/> Yes
Motor 1-4	Radio binary input 2	<input checked="" type="radio"/> No <input type="radio"/> Yes
Functions motor 1-4	Radio binary input 3	<input checked="" type="radio"/> No <input type="radio"/> Yes
Electronic motors	Radio binary input 4	<input checked="" type="radio"/> No <input type="radio"/> Yes
Bus safety	Radio binary input 5	<input checked="" type="radio"/> No <input type="radio"/> Yes
Feedback motor position		
General: Radio binary inputs		

6.13.1 Radio binary input 1...5

- Default value:
 - No
- Selection options:
 - No
 - Yes

With the parameter “Yes” additional menu index cards “Radio binary input 1...5” become visible. At the same time the necessary objects appear.

6.14 General information for radio input

For every radio input there are five different basic functions for selection:

- Default value:
 - Venetian blind, Up/Down
- Selection options:
 - Venetian blind, Up/Down
 - Switch
 - 8-Bit value (rising edge)
 - Dimming
 - Venetian blind slow tilting

The single functions and parameters which arise depending on the selection of the basic functions are now described. To illustrate this, another basis function has been selected for each radio input. The functions are described with the help of the radio input 1 (channel A) and are identical for the radio inputs 2 - 5 (channel B, C, D and E).

6.15 Menu index card “Radio inputs – Venetian blinds Up/Down”

1.1.1 animeo KNX 4 DC Motor Controller WM > Radio binary input 1		
General	Basic function	Venetian blind, Up/Down
Motor 1-4	Long operation (action) after	0,5 Seconds
Functions motor 1-4	Functionality of the my push button	1-Bit value
Electronic motors	Functionality of the my push button 1-Bit value	On
Bus safety		
Feedback motor position		
General: Radio binary inputs		
Radio binary input 1		
	Radio binary input 2	
	Radio binary input 3	
	Radio binary input 4	
	Radio binary input 5	

6.15.1 Basic Function

Selected option:

- Venetian blind, Up/Down

6.15.2 Long operation (action) after

Default value:

- 0.5 seconds

 Selection options:

- 0.3...5.0 seconds

This parameter defines the activity time of the corresponding transmitter push button which distinguishes between the sending of a short-term telegram (Step/Stop) and a long-term telegram (Up/Down). If the time, for example, is parameterized on 0.5 seconds, then only after a pressing of more than 0.5 seconds is a long-term telegram generated. With a pressing of the push button which is shorter than 0.5 seconds, a short-term telegram is generated.

6.15.3 Functionality of my push button

Default value:

- No function

 Selection options:

- 1-Bit value
- 8-Bit value
- No function

6.15.3.1 1-Bit value

Default value:

- On

 Selection options:

- On
- Off
- Toggle
- No function

- **On**

If the “my” button in the radio transmitter is pressed, the object value “On” is generated. The duration of the activity is not evaluated.

- **Off**

If the “my” button in the radio transmitter is pressed, the object value “Off” is generated. The duration of the activity is not evaluated.

- **Toggle**

If the “my” button in the radio transmitter is pressed, the object value toggles between “On” and “Off”. The duration of the activity is not evaluated.

- **No function**

If the “my” button in the radio transmitter is pressed, no object is generated.

△ See chapter 1 Definitions for On (“1”) Off (“0”) Toggle (“1/0”).

6.15.3.2 8-Bit value

- Default value: • 0
 Selection options: • 0
 • 0 – 255

With this parameter the value (0 – 255) is set which is transmitted while pressing the “my” button in the radio transmitter.

6.15.3.3 No function

If the “my” button in the radio transmitter is pressed, no object is generated.

6.16 Menu index card “Radio inputs – Switch”

1.1.1 animeo KNX 4 DC Motor Controller WM > Radio binary input 1		
General	Basic function	Switch
Motor 1-4	Functionality of the Up push button	On
Functions motor 1-4	Functionality of the Down push button	Off
Electronic motors	Functionality of the my push button	1-Bit value
Bus safety	Functionality of the my push button 1-Bit value	On
Feedback motor position		
General: Radio binary inputs		
Radio binary input 1		
Radio binary input 2		
Radio binary input 3		
Radio binary input 4		
Radio binary input 5		

6.16.1 Basic Function

- Selected option: • Switch

6.16.2 Functionality of the Up push button

- Default value: • On
Selection options: • On
 • Off
 • Toggle
 • No function

- **On**

If the “Up” button in the radio transmitter is pressed, the object value “On” is generated. The duration of the activity is not evaluated.

- **Off**

If the “Up” button in the radio transmitter is pressed, the object value “Off” is generated. The duration of the activity is not evaluated.

- **Toggle**

If the “Up” button in the radio transmitter is pressed, the object value toggles between “On” and “Off”. The duration of the activity is not evaluated.

- **No function**

If the “Up” button in the radio transmitter is pressed, no object is generated.

△ See chapter 1 Definitions for On (“1”) Off (“0”) Toggle (“1/0”).

6.16.3 Functionality of the Down push button

- Default value: • Off
Selection options: • On
 • Off
 • Toggle
 • No function

- **On**

If the “Down” button in the radio transmitter is pressed, the object value “On” is generated. The duration of the activity is not evaluated.

- **Off**

If the “Down” button in the radio transmitter is pressed, the object value “Off” is generated. The duration of the activity is not evaluated.

- **Toggle**

If the “Down” button in the radio transmitter is pressed, the object value toggles between “On” and “Off”. The duration of the activity is not evaluated.

- **No function**

If the “Down” button in the radio transmitter is pressed, no object is generated.

△ See chapter 1 Definitions for On (“1”) Off (“0”) Toggle (“1/0”).

6.16.4 Functionality of my push button

- Default value: • No function
Selection options: • 1-Bit value
 • 8-Bit value
 • No function

6.16.4.1 1-Bit value

- Default value: • On
Selection options: • On
 • Off
 • Toggle
 • No function

• On

If the “my” button in the radio transmitter is pressed, the object value “On” is generated. The duration of the activity is not evaluated.

• Off

If the “my” button in the radio transmitter is pressed, the object value “Off” is generated. The duration of the activity is not evaluated.

• Toggle

If the “my” button in the radio transmitter is pressed, the object value toggles between “On” and “Off”. The duration of the activity is not evaluated.

• No function

If the “my” button in the radio transmitter is pressed, no object is generated.

△ See chapter 1 Definitions for On (“1”) Off (“0”) Toggle (“1/0”).

6.16.4.2 8-Bit value

- Default value: • 0
Selection options: • 0 – 255

With this parameter the value (0 – 255) is set which is transmitted while pressing the “my” button in the radio transmitter.

6.16.4.3 No function

If the “my” button in the radio transmitter is pressed, no object is generated.

6.17 Menu index card “Radio inputs – 8-Bit value”

1.1.1 animeo KNX 4 DC Motor Controller WM > Radio binary input 1		
General	Basic function	8-Bit value
Motor 1-4	Value of the Up push button	0
Functions motor 1-4	Value of the Down push button	0
Electronic motors	Functionality of the my push button	1-Bit value
Bus safety	Functionality of the my push button 1-Bit value	On
Feedback motor position		
General: Radio binary inputs		
Radio binary input 1		
	Radio binary input 2	
	Radio binary input 3	
	Radio binary input 4	
	Radio binary input 5	

6.17.1 Basic Function

Selected option:

- 8-Bit value (rising edge)

6.17.2 Value of the Up push button

Default value:

- 0

 Selection options:

- 0 – 255

With this parameter the value (0 – 255) is set which is transmitted while pressing the “my” button in the radio transmitter.

6.17.3 Value of the Down push button

Default value:

- 0

 Selection options:

- 0 – 255

With this parameter the value is set which is transmitted while pressing the “Down” button in the radio transmitter.

6.17.4 Functionality of my push button

Default value:

- No function

 Selection options:

- 1-Bit value
- 8-Bit value
- No function

6.17.4.1 1-Bit value

Default value:

- On

 Selection options:

- On
- Off
- Toggle
- No function

- **On**

If the “my” button in the radio transmitter is pressed, the object value “On” is generated. The duration of the activity is not evaluated.

- **Off**

If the “my” button in the radio transmitter is pressed, the object value “Off” is generated. The duration of the activity is not evaluated.

- **Toggle**

If the “my” button in the radio transmitter is pressed, the object value toggles between “On” and “Off”. The duration of the activity is not evaluated.

- **No function**

If the “my” button in the radio transmitter is pressed, no object is generated.

△ See chapter 1 Definitions for On (“1”) Off (“0”) Toggle (“1/0”).

6.17.4.2 8-Bit value

Default value: • 0
Selection options: • 0 – 255

With this parameter the value (0 – 255) is set which is transmitted while pressing the “my” button in the radio transmitter.

6.17.4.3 No function

If the “my” button in the radio transmitter is pressed, no object is generated.

6.18 Menu index card “Radio inputs – Dimming”

1.1.1 animeo KNX 4 DC Motor Controller WM > Radio binary input 1		
General	Basic function	Dimming
Motor 1-4	Long operation (action) after	0,5 Seconds
Functions motor 1-4	Dimming Brighter/Darker	Adjust by 1/8
Electronic motors	Functionality of the my push button	1-Bit value
Bus safety	Functionality of the my push button	On
Feedback motor position	1-Bit value	
General: Radio binary inputs		
Radio binary input 1		
Radio binary input 2		
Radio binary input 3		
Radio binary input 4		
Radio binary input 5		

6.18.1 Basic Function

Selected option:

- Dimming

6.18.2 Long operation (action) after

Default value:

- 0.5 seconds

 Selection options:

- 0.3...5.0 seconds

This parameter defines the pressing time of the corresponding transmitter push button (Up/Down) which makes a distinction between the sending of a short-term telegram (On/Off) and a long-term telegram (Brighter/darker dimming). If the time, for example, is set at 0.5 seconds, a long-term telegram is generated after a longer pressing than 0.5 seconds. With a pressing duration which is shorter than 0.5 seconds, a short-term telegram is generated.

6.18.3 Dimming Brighter/Darker

Default value:

- Adjust by $\frac{1}{8}$

 Selection options:

- Adjust by 100 % $\frac{1}{16}$

This parameter defines the dimming step length which is transmitted as a telegram with a long pressing of the push button.

6.18.4 Functionality of my push button

Default value:

- No function

 Selection options:

- 1-Bit value
- 8-Bit value
- No function

6.18.4.1 1-Bit value

- Default value: • On
Selection options: • On
 • Off
 • Toggle
 • No function

- **On**

If the “my” button in the radio transmitter is pressed, the object value “On” is generated. The duration of the activity is not evaluated.

- **Off**

If the “my” button in the radio transmitter is pressed, the object value “Off” is generated. The duration of the activity is not evaluated.

- **Toggle**

If the “my” button in the radio transmitter is pressed, the object value toggles between “On” and “Off”. The duration of the activity is not evaluated.

- **No function**

If the “my” button in the radio transmitter is pressed, no object is generated.

△ See chapter 1 Definitions for On (“1”) Off (“0”) Toggle (“1/0”).

6.18.4.2 8-Bit value

- Default value: • 0
Selection options: • 0 – 255

With this parameter the value (0 – 255) is set which is transmitted while pressing the “my” button in the radio transmitter.

6.18.4.3 No function

If the “my” button in the radio transmitter is pressed, no object is generated.

6.19 Menu index card “Radio inputs – Venetian blind slow tilting”

1.1.1 animeo KNX 4 DC Motor Controller WM > Radio binary input 1		
General	Basic function	Venetian blind slow tilting
Motor 1-4	Long operation (action) after	0,5 Seconds
Functions motor 1-4	Tilt slats slowly Open/Close	Adjust by 1/8
Electronic motors	Functionality of the my push button	1-Bit value
Bus safety	Functionality of the my push button 1-Bit value	On
Feedback motor position		
General: Radio binary inputs		
Radio binary input 1		
Radio binary input 2		
Radio binary input 3		
Radio binary input 4		
Radio binary input 5		

6.19.1 Basic Function

Selected option:

- Venetian blind slow tilting

6.19.2 Long operation (action) after

This parameter defines the pressing time of the corresponding transmitter push button (Up/Down) which makes a distinction between the sending of a short-term telegram (Up/Down) and a long-term telegram (Open/Close). If the time, for example, is set at 0.5 seconds, a longterm telegram is generated after a longer pressing than 0.5 seconds. With a pressing duration which is shorter than 0.5 seconds, a shortterm telegram is generated.

6.19.3 Tilt slats slowly Open/Close

This parameter defines the turn of the Venetian blinds which is transmitted as a telegram with a long pressing of the push button.

6.19.4 Functionality of my push button

Default value:

- No function

 Selection options:

- 1-Bit value
- 8-Bit value
- No function

6.19.4.1 1-Bit value

Default value:

- On

 Selection options:

- On
- Off
- Toggle
- No function

- **On**

If the “my” button in the radio transmitter is pressed, the object value “On” is generated. The duration of the activity is not evaluated.

- **Off**

If the “my” button in the radio transmitter is pressed, the object value “Off” is generated. The duration of the activity is not evaluated.

- **Toggle**

If the “my” button in the radio transmitter is pressed, the object value toggles between “On” and “Off”. The duration of the activity is not evaluated.

- **No function**

If the “my” button in the radio transmitter is pressed, no object is generated.

△ See chapter 1 Definitions for On (“1”) Off (“0”) Toggle (“1/0”).

6.19.4.2 8-Bit value

Default value: • 0

Selection options: • 0 – 255

With this parameter the value (0 – 255) is set which is transmitted while pressing the “my” button in the radio transmitter.

6.19.4.3 No function

If the “my” button in the radio transmitter is pressed, no object is generated.

7 Technical data

KNX 4 DC Motor Controller	WM Ref. 1870452
Supply voltage	24 V DC (min. 21.5 V DC - max. 28 V DC)
Stand-by current (IEC 62301)	50 mA @ 24 V DC
Stand-by power (IEC 62301)	300 mW @ 24 V DC
Supply voltage from KNX Bus	KNX-voltage 21 ... 30 V DC, SELV
Rated current consumption KNX	As per KNX guidelines, 10mA
Max. motor current consumption	4 x 2.3 A @ 24 V DC
Supply voltage of group control input	SELV, 16 V DC =
Supply voltage of local push buttons	SELV, 16 V DC =
Terminals	Spring connectors
Relay micro-gap	μ
Terminal KNX	KNX bus terminal (black/red)
Running time per output	Max. 5 minutes
Operating temperature	-5° C to 45° C
Relative humidity	max. 85%
Material of housing	PC-ABS
Housing dimensions	180 x 255 x 61 mm
Weight	700 g
Degree of protection	IP 20
Protection class	
Conformity	www.somfy.com/ce

Somfy Activites SA

50 Avenue du Nouveau Monde

74300 Cluses

Frankreich

www.somfy.com/projects